

Doppelsteg Breitband-Hornantenne BBHA 9120 B

Double Ridged Broadband Horn Antenna BBHA 9120 B

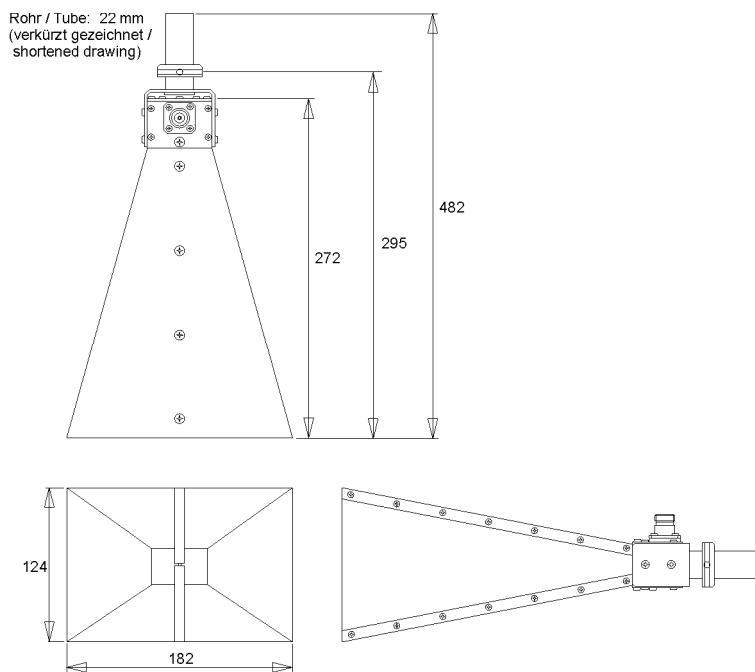

Beschreibung:

Linear polarisierte Doppelsteg Breitband Hornantenne in Aluminium-ausführung für Empfangs- und Sendeanwendungen.

Description:

Linear polarized double ridged broadband horn antenna for receive and transmit applications made of aluminium.

Technische Daten:		Specifications:
Frequenzbereich, nominell:	1.5...10 GHz	Nominal Frequency Range:
Nutzbarer Frequenzbereich:	1 ... 10.5 GHz	Usable Frequency Range:
Isotropgewinn:	5 ... 18 dBi	Isotropic Gain:
Antennenfaktor:	25 ... 33 dB/m	Antenna Factor:
Impedanz, nominell:	50 Ω	Nominal Impedance:
Stehwellenverhältnis SWR typisch:	< 1.5	Standing Wave Ratio SWR typical:
Stehwellenverhältnis SWR max.:	< 2.5 (f > 1.5 GHz)	Standing Wave Ratio SWR max.:
Vor- Rückverhältnis:	typ. > 25 dB (f > 1.3 GHz)	Front to Back Ratio:
Polarisationsentkopplung:	typ. > 25 dB	Cross Polarisation:
3 dB Öffnungswinkel typ.(E-Ebene):	≈ 34°	3 dB Beamwidth typ. (E-Plane):
3 dB Öffnungswinkel typ.(H-Ebene):	≈ 32°	3 dB Beamwidth typ. (H-Plane):
Max. Eingangsleistung:	300 W (cont.)	Max. Input Power:
Anschlußart: N-Buchse		N-Connector female
Halterung: 22 mm Rohr, Rastring		Mount: 22 mm Tube, Indexing Ring
Breite x Länge x Höhe:	184 x 272 (480) x 128 mm	Width x Length x Height:
Gewicht:	1.2 kg	Weight:



Isotropgewinn

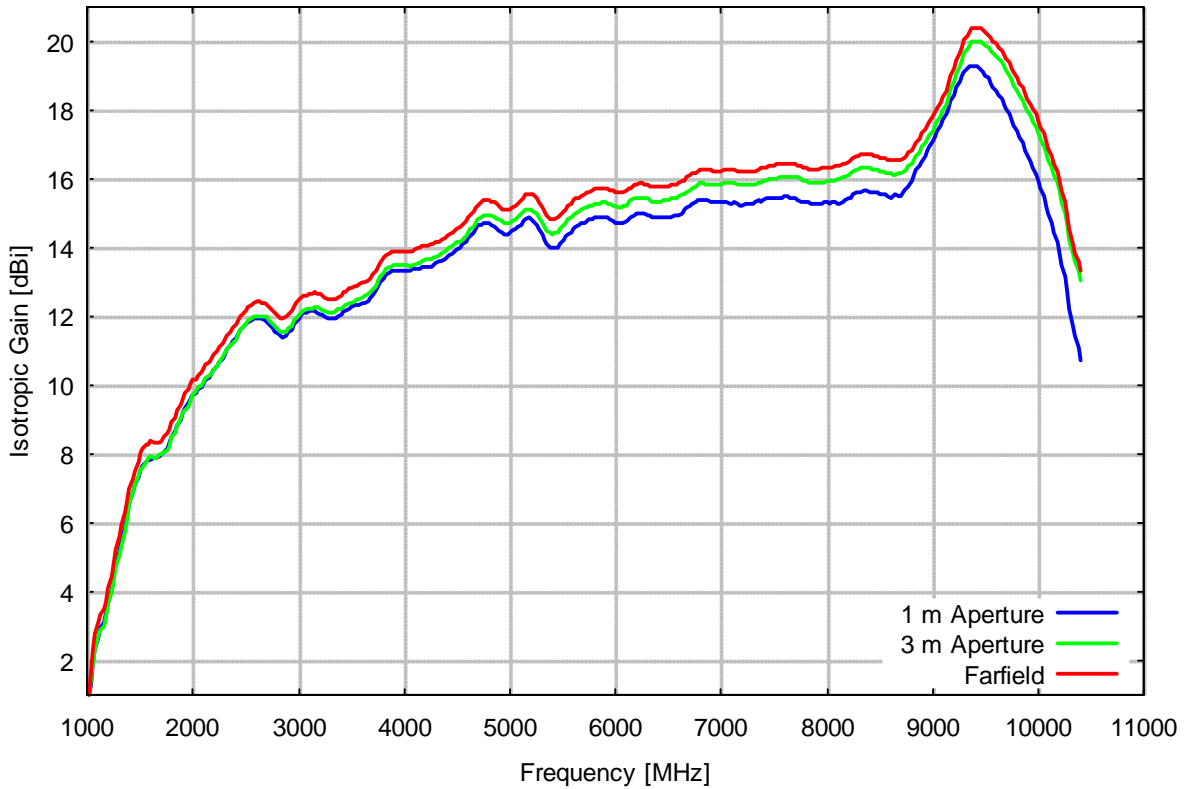

Antennenwandlungsmaß

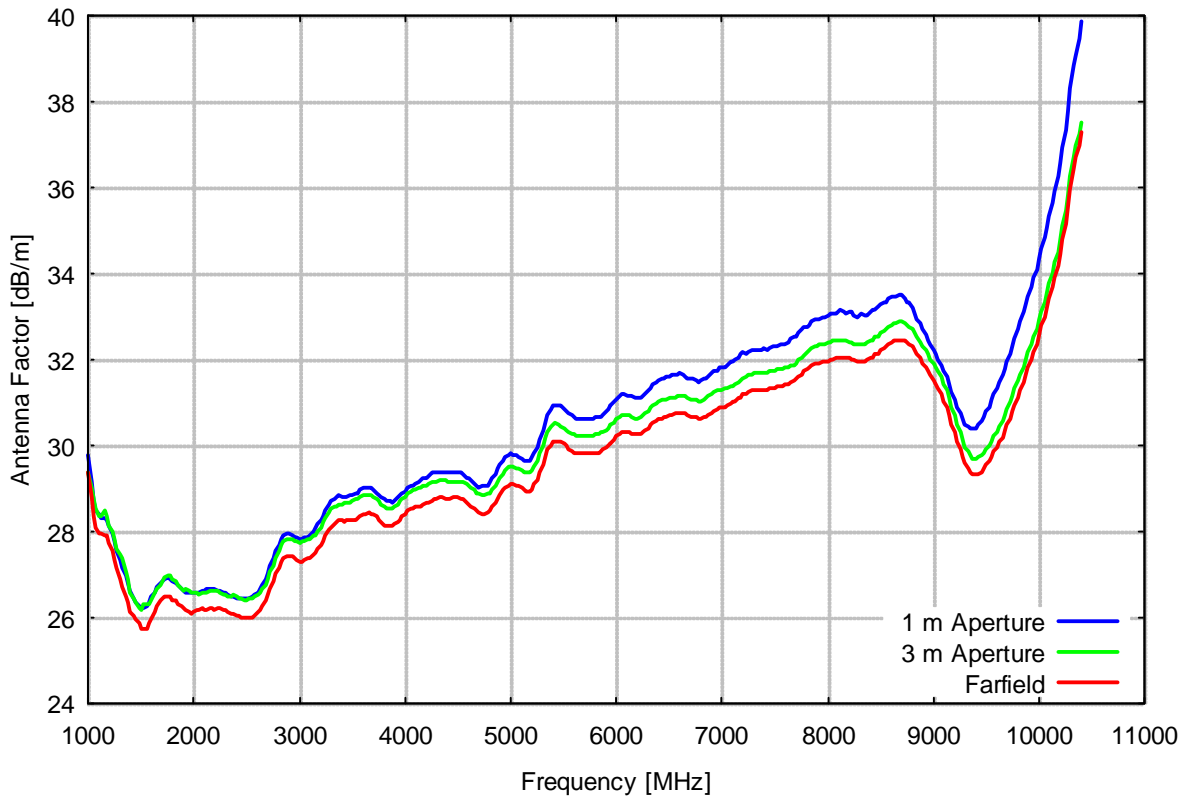

Frequency	Gain(Isotr.) 1 m Apert.	Ant.-Factor 1 m Apert.	Gain(Isotr.) 3 m Apert.	Ant.-Factor 3 m Apert.	Gain(Isotr.) Farfield	Ant.-Factor Farfield
MHz	dBi	dB/m	dBi	dB/m	dBi	dB/m
1000.00	0.45	29.77	0.83	29.39	0.87	29.35
1025.00	1.28	29.15	1.42	29.01	1.67	28.77
1050.00	1.94	28.70	1.91	28.73	2.31	28.34
1075.00	2.35	28.50	2.34	28.51	2.78	28.07
1100.00	2.68	28.37	2.69	28.36	3.11	27.93
1125.00	2.92	28.32	2.88	28.36	3.31	27.93
1150.00	3.12	28.31	2.97	28.46	3.51	27.92
1175.00	3.37	28.25	3.26	28.36	3.71	27.91
1200.00	3.68	28.13	3.68	28.13	4.08	27.72
1225.00	4.03	27.96	4.00	27.98	4.45	27.53
1250.00	4.41	27.75	4.32	27.83	4.82	27.34
1275.00	4.80	27.53	4.73	27.60	5.19	27.14
1300.00	5.16	27.34	5.06	27.44	5.61	26.89
1325.00	5.50	27.17	5.31	27.35	5.94	26.72
1350.00	5.86	26.97	5.74	27.08	6.35	26.48
1375.00	6.21	26.78	6.10	26.88	6.64	26.35
1400.00	6.53	26.61	6.55	26.59	7.01	26.14
1425.00	6.86	26.44	6.86	26.44	7.26	26.03
1450.00	7.09	26.35	7.11	26.34	7.50	25.94
1475.00	7.34	26.26	7.39	26.20	7.75	25.84
1500.00	7.52	26.22	7.55	26.19	8.03	25.71
1525.00	7.66	26.23	7.59	26.30	8.18	25.71
1550.00	7.76	26.27	7.74	26.29	8.29	25.74
1575.00	7.82	26.34	7.86	26.30	8.29	25.87
1600.00	7.83	26.47	7.93	26.38	8.36	25.95
1625.00	7.86	26.58	7.85	26.58	8.33	26.11
1650.00	7.87	26.70	7.89	26.68	8.33	26.24
1675.00	7.92	26.78	7.97	26.73	8.32	26.38
1700.00	7.98	26.85	8.01	26.82	8.40	26.43
1725.00	8.05	26.90	8.02	26.93	8.48	26.47
1750.00	8.16	26.92	8.12	26.96	8.61	26.47
1775.00	8.33	26.87	8.23	26.97	8.73	26.47
1800.00	8.50	26.83	8.46	26.86	8.92	26.40
1825.00	8.67	26.78	8.60	26.84	9.04	26.41
1850.00	8.84	26.73	8.83	26.73	9.24	26.32
1875.00	9.01	26.67	9.04	26.64	9.41	26.27
1900.00	9.20	26.60	9.19	26.60	9.59	26.21
1925.00	9.34	26.57	9.27	26.64	9.74	26.17
1950.00	9.46	26.56	9.39	26.63	9.89	26.13
1975.00	9.58	26.56	9.54	26.59	10.03	26.10
2000.00	9.69	26.55	9.69	26.56	10.13	26.11
2025.00	9.79	26.56	9.80	26.55	10.18	26.17
2050.00	9.88	26.58	9.92	26.54	10.28	26.17
2075.00	9.95	26.62	10.01	26.55	10.36	26.20
2100.00	10.03	26.63	10.09	26.57	10.47	26.19
2125.00	10.13	26.64	10.19	26.58	10.57	26.19
2150.00	10.22	26.65	10.25	26.62	10.65	26.22
2175.00	10.32	26.65	10.33	26.63	10.77	26.20
2200.00	10.43	26.64	10.43	26.63	10.88	26.19
2225.00	10.53	26.63	10.55	26.62	10.96	26.21
2250.00	10.65	26.61	10.67	26.59	11.07	26.20
2275.00	10.77	26.59	10.82	26.54	11.18	26.18
2300.00	10.89	26.56	10.94	26.51	11.31	26.15

Frequency	Gain(Isotr.) 1 m Apert.	Ant.-Factor 1 m Apert.	Gain(Isotr.) 3 m Apert.	Ant.-Factor 3 m Apert.	Gain(Isotr.) Farfield	Ant.-Factor Farfield
MHz	dBi	dB/m	dBi	dB/m	dBi	dB/m
2325.00	11.03	26.52	11.06	26.49	11.44	26.11
2350.00	11.14	26.50	11.14	26.50	11.54	26.10
2375.00	11.25	26.48	11.21	26.52	11.67	26.07
2400.00	11.36	26.46	11.33	26.50	11.78	26.04
2425.00	11.48	26.44	11.47	26.45	11.90	26.02
2450.00	11.58	26.42	11.57	26.43	11.99	26.01
2475.00	11.68	26.42	11.68	26.41	12.09	26.00
2500.00	11.75	26.43	11.76	26.41	12.17	26.01
2525.00	11.82	26.45	11.85	26.42	12.27	25.99
2550.00	11.88	26.47	11.93	26.42	12.34	26.01
2575.00	11.92	26.52	11.96	26.48	12.38	26.05
2600.00	11.94	26.58	11.97	26.54	12.41	26.11
2625.00	11.95	26.65	12.01	26.59	12.42	26.19
2650.00	11.93	26.76	12.01	26.68	12.40	26.28
2675.00	11.89	26.88	12.00	26.77	12.37	26.39
2700.00	11.83	27.02	11.96	26.89	12.33	26.52
2725.00	11.74	27.18	11.88	27.05	12.26	26.67
2750.00	11.64	27.36	11.79	27.21	12.17	26.84
2775.00	11.53	27.55	11.71	27.38	12.08	27.01
2800.00	11.46	27.70	11.60	27.56	12.01	27.15
2825.00	11.42	27.82	11.55	27.69	11.95	27.29
2850.00	11.40	27.91	11.54	27.78	11.95	27.37
2875.00	11.44	27.96	11.56	27.83	11.97	27.43
2900.00	11.52	27.95	11.64	27.83	12.04	27.43
2925.00	11.62	27.92	11.73	27.81	12.15	27.40
2950.00	11.75	27.87	11.85	27.77	12.27	27.35
2975.00	11.84	27.85	11.94	27.75	12.36	27.33
3000.00	11.94	27.82	12.02	27.74	12.46	27.30
3025.00	12.03	27.81	12.08	27.75	12.53	27.30
3050.00	12.07	27.84	12.15	27.76	12.59	27.31
3075.00	12.11	27.87	12.18	27.80	12.60	27.38
3100.00	12.14	27.91	12.22	27.83	12.65	27.39
3125.00	12.14	27.98	12.23	27.89	12.66	27.45
3150.00	12.13	28.06	12.28	27.91	12.68	27.51
3175.00	12.09	28.17	12.26	28.00	12.65	27.60
3200.00	12.06	28.26	12.22	28.10	12.65	27.67
3225.00	12.03	28.36	12.17	28.22	12.60	27.79
3250.00	11.96	28.50	12.16	28.30	12.55	27.91
3275.00	11.92	28.61	12.10	28.42	12.49	28.03
3300.00	11.91	28.68	12.07	28.52	12.49	28.10
3325.00	11.92	28.74	12.08	28.58	12.48	28.17
3350.00	11.94	28.78	12.14	28.58	12.50	28.22
3375.00	11.97	28.82	12.18	28.61	12.54	28.24
3400.00	12.04	28.81	12.23	28.62	12.61	28.24
3425.00	12.13	28.79	12.28	28.64	12.68	28.23
3450.00	12.17	28.81	12.33	28.65	12.73	28.25
3475.00	12.21	28.83	12.37	28.67	12.79	28.25
3500.00	12.27	28.83	12.39	28.71	12.84	28.26
3525.00	12.31	28.86	12.43	28.73	12.89	28.28
3550.00	12.32	28.90	12.47	28.75	12.90	28.32
3575.00	12.32	28.96	12.49	28.79	12.94	28.34
3600.00	12.35	29.00	12.52	28.83	12.97	28.37
3625.00	12.40	29.00	12.58	28.83	13.01	28.40
3650.00	12.45	29.02	12.63	28.84	13.04	28.42

Frequency	Gain(Isotr.) 1 m Apert.	Ant.-Factor 1 m Apert.	Gain(Isotr.) 3 m Apert.	Ant.-Factor 3 m Apert.	Gain(Isotr.) Farfield	Ant.-Factor Farfield
MHz	dBi	dB/m	dBi	dB/m	dBi	dB/m
3675.00	12.52	29.01	12.69	28.84	13.12	28.41
3700.00	12.62	28.96	12.77	28.81	13.20	28.38
3725.00	12.74	28.90	12.89	28.75	13.30	28.34
3750.00	12.86	28.84	13.02	28.68	13.42	28.28
3775.00	12.98	28.78	13.15	28.61	13.56	28.20
3800.00	13.08	28.73	13.26	28.56	13.68	28.14
3825.00	13.18	28.70	13.36	28.52	13.75	28.12
3850.00	13.25	28.68	13.41	28.52	13.80	28.12
3875.00	13.31	28.67	13.44	28.54	13.85	28.14
3900.00	13.33	28.71	13.47	28.58	13.86	28.18
3925.00	13.32	28.77	13.47	28.62	13.87	28.22
3950.00	13.33	28.83	13.46	28.69	13.87	28.28
3975.00	13.34	28.86	13.46	28.75	13.86	28.34
4000.00	13.34	28.92	13.46	28.80	13.87	28.39
4025.00	13.31	29.01	13.46	28.86	13.86	28.46
4050.00	13.30	29.07	13.45	28.92	13.86	28.51
4075.00	13.35	29.07	13.47	28.95	13.89	28.53
4100.00	13.39	29.08	13.49	28.98	13.92	28.55
4125.00	13.39	29.14	13.52	29.01	13.96	28.57
4150.00	13.37	29.21	13.55	29.03	14.00	28.58
4175.00	13.41	29.23	13.59	29.04	14.03	28.61
4200.00	13.44	29.24	13.63	29.05	14.05	28.64
4225.00	13.45	29.29	13.65	29.08	14.06	28.67
4250.00	13.44	29.35	13.66	29.13	14.07	28.71
4275.00	13.47	29.37	13.70	29.14	14.10	28.73
4300.00	13.52	29.37	13.73	29.16	14.13	28.76
4325.00	13.57	29.37	13.76	29.18	14.16	28.78
4350.00	13.61	29.38	13.80	29.19	14.22	28.77
4375.00	13.66	29.38	13.86	29.18	14.28	28.76
4400.00	13.71	29.38	13.93	29.16	14.34	28.75
4425.00	13.75	29.39	13.98	29.16	14.38	28.76
4450.00	13.81	29.37	14.02	29.16	14.42	28.77
4475.00	13.87	29.36	14.08	29.16	14.46	28.78
4500.00	13.92	29.37	14.13	29.15	14.52	28.77
4525.00	13.98	29.36	14.17	29.16	14.58	28.75
4550.00	14.07	29.31	14.22	29.16	14.65	28.73
4575.00	14.17	29.25	14.31	29.12	14.75	28.67
4600.00	14.26	29.22	14.41	29.06	14.85	28.63
4625.00	14.34	29.18	14.52	29.00	14.94	28.58
4650.00	14.45	29.12	14.62	28.95	15.04	28.53
4675.00	14.56	29.06	14.71	28.90	15.13	28.48
4700.00	14.63	29.03	14.80	28.86	15.22	28.45
4725.00	14.67	29.04	14.86	28.85	15.30	28.41
4750.00	14.71	29.04	14.91	28.85	15.35	28.40
4775.00	14.73	29.07	14.93	28.87	15.38	28.42
4800.00	14.71	29.14	14.94	28.90	15.37	28.48
4825.00	14.66	29.23	14.93	28.96	15.34	28.55
4850.00	14.60	29.33	14.89	29.05	15.29	28.64
4875.00	14.54	29.44	14.84	29.14	15.24	28.74
4900.00	14.47	29.55	14.79	29.23	15.18	28.85
4925.00	14.42	29.65	14.74	29.33	15.12	28.95
4950.00	14.39	29.72	14.69	29.42	15.09	29.03
4975.00	14.38	29.77	14.68	29.48	15.09	29.07
5000.00	14.40	29.80	14.70	29.50	15.11	29.09

Frequency	Gain(Isotr.) 1 m Apert.	Ant.-Factor 1 m Apert.	Gain(Isotr.) 3 m Apert.	Ant.-Factor 3 m Apert.	Gain(Isotr.) Farfield	Ant.-Factor Farfield
MHz	dBi	dB/m	dBi	dB/m	dBi	dB/m
5025.00	14.46	29.79	14.75	29.50	15.15	29.09
5050.00	14.54	29.75	14.81	29.47	15.21	29.07
5075.00	14.60	29.73	14.89	29.44	15.28	29.05
5100.00	14.67	29.70	14.97	29.40	15.36	29.01
5125.00	14.76	29.65	15.04	29.37	15.45	28.97
5150.00	14.84	29.62	15.09	29.36	15.51	28.94
5175.00	14.86	29.64	15.12	29.38	15.56	28.94
5200.00	14.82	29.72	15.11	29.43	15.55	28.99
5225.00	14.76	29.82	15.06	29.52	15.51	29.08
5250.00	14.67	29.95	14.98	29.65	15.41	29.21
5275.00	14.54	30.12	14.86	29.80	15.29	29.37
5300.00	14.37	30.33	14.73	29.97	15.15	29.56
5325.00	14.22	30.53	14.60	30.15	15.02	29.73
5350.00	14.09	30.70	14.48	30.31	14.90	29.88
5375.00	14.01	30.82	14.40	30.42	14.83	30.00
5400.00	13.96	30.91	14.38	30.49	14.79	30.08
5425.00	13.96	30.94	14.40	30.51	14.81	30.10
5450.00	14.01	30.94	14.45	30.49	14.85	30.09
5475.00	14.08	30.91	14.54	30.45	14.93	30.06
5500.00	14.19	30.84	14.63	30.40	15.01	30.02
5525.00	14.29	30.78	14.72	30.35	15.10	29.97
5550.00	14.37	30.74	14.81	30.30	15.18	29.92
5575.00	14.45	30.69	14.87	30.27	15.28	29.87
5600.00	14.54	30.64	14.94	30.24	15.35	29.83
5625.00	14.62	30.60	15.00	30.22	15.41	29.82
5650.00	14.67	30.59	15.04	30.22	15.45	29.81
5675.00	14.68	30.62	15.09	30.21	15.50	29.80
5700.00	14.73	30.61	15.13	30.21	15.54	29.80
5725.00	14.78	30.60	15.16	30.22	15.57	29.80
5750.00	14.80	30.61	15.20	30.22	15.60	29.81
5775.00	14.82	30.63	15.22	30.23	15.65	29.80
5800.00	14.85	30.64	15.24	30.25	15.68	29.81
5825.00	14.87	30.65	15.26	30.26	15.71	29.82
5850.00	14.89	30.67	15.28	30.28	15.72	29.85
5875.00	14.88	30.72	15.29	30.31	15.72	29.88
5900.00	14.87	30.77	15.29	30.35	15.71	29.93
5925.00	14.85	30.83	15.27	30.41	15.69	29.98
5950.00	14.79	30.92	15.24	30.47	15.66	30.05
5975.00	14.76	30.99	15.22	30.52	15.62	30.12
6000.00	14.73	31.06	15.19	30.59	15.59	30.20
6025.00	14.69	31.13	15.17	30.65	15.57	30.25
6050.00	14.69	31.17	15.17	30.69	15.57	30.28
6075.00	14.72	31.17	15.19	30.70	15.60	30.29
6100.00	14.77	31.16	15.23	30.69	15.62	30.31
6125.00	14.82	31.15	15.29	30.68	15.68	30.29
6150.00	14.87	31.13	15.35	30.65	15.73	30.26
6175.00	14.94	31.10	15.40	30.63	15.79	30.24
6200.00	14.99	31.08	15.43	30.63	15.83	30.24
6225.00	14.99	31.11	15.45	30.66	15.86	30.24
6250.00	14.97	31.16	15.44	30.70	15.85	30.28
6275.00	14.97	31.20	15.42	30.75	15.84	30.33
6300.00	14.95	31.26	15.40	30.81	15.81	30.40
6325.00	14.91	31.34	15.36	30.88	15.78	30.46
6350.00	14.87	31.41	15.34	30.93	15.76	30.51

Frequency	Gain(Isotr.) 1 m Apert.	Ant.-Factor 1 m Apert.	Gain(Isotr.) 3 m Apert.	Ant.-Factor 3 m Apert.	Gain(Isotr.) Farfield	Ant.-Factor Farfield
MHz	dBi	dB/m	dBi	dB/m	dBi	dB/m
6375.00	14.86	31.45	15.34	30.97	15.75	30.56
6400.00	14.86	31.49	15.34	31.00	15.75	30.59
6425.00	14.85	31.53	15.34	31.04	15.76	30.62
6450.00	14.85	31.56	15.35	31.07	15.76	30.65
6475.00	14.87	31.58	15.37	31.07	15.77	30.67
6500.00	14.87	31.61	15.38	31.09	15.78	30.70
6525.00	14.88	31.63	15.40	31.11	15.79	30.72
6550.00	14.91	31.63	15.42	31.12	15.81	30.74
6575.00	14.93	31.64	15.45	31.13	15.83	30.75
6600.00	14.95	31.66	15.48	31.13	15.85	30.76
6625.00	15.00	31.65	15.51	31.14	15.90	30.74
6650.00	15.08	31.59	15.55	31.13	15.95	30.73
6675.00	15.15	31.56	15.61	31.10	16.01	30.70
6700.00	15.19	31.55	15.67	31.07	16.07	30.67
6725.00	15.24	31.53	15.72	31.06	16.12	30.65
6750.00	15.33	31.48	15.76	31.04	16.17	30.64
6775.00	15.38	31.46	15.81	31.02	16.22	30.62
6800.00	15.37	31.50	15.85	31.02	16.25	30.62
6825.00	15.37	31.54	15.85	31.05	16.26	30.64
6850.00	15.38	31.55	15.84	31.09	16.26	30.67
6875.00	15.37	31.60	15.84	31.13	16.25	30.71
6900.00	15.34	31.66	15.82	31.18	16.24	30.76
6925.00	15.32	31.71	15.81	31.22	16.22	30.81
6950.00	15.32	31.74	15.80	31.26	16.22	30.84
6975.00	15.30	31.79	15.82	31.27	16.22	30.87
7000.00	15.30	31.82	15.83	31.29	16.23	30.89
7025.00	15.32	31.83	15.85	31.30	16.25	30.90
7050.00	15.31	31.87	15.85	31.33	16.26	30.93
7075.00	15.28	31.93	15.87	31.35	16.27	30.95
7100.00	15.28	31.96	15.87	31.38	16.25	30.99
7125.00	15.30	31.98	15.85	31.43	16.25	31.03
7150.00	15.27	32.04	15.83	31.47	16.22	31.08
7175.00	15.22	32.12	15.82	31.52	16.21	31.12
7200.00	15.22	32.15	15.81	31.56	16.19	31.17
7225.00	15.25	32.14	15.80	31.59	16.18	31.21
7250.00	15.26	32.16	15.80	31.63	16.18	31.24
7275.00	15.24	32.22	15.81	31.64	16.19	31.26
7300.00	15.26	32.23	15.83	31.66	16.20	31.28
7325.00	15.32	32.19	15.84	31.67	16.23	31.28
7350.00	15.35	32.19	15.88	31.67	16.27	31.28
7375.00	15.34	32.23	15.89	31.68	16.29	31.29
7400.00	15.37	32.24	15.92	31.68	16.32	31.29
7425.00	15.40	32.23	15.94	31.69	16.34	31.29
7450.00	15.41	32.25	15.96	31.70	16.37	31.30
7475.00	15.41	32.28	15.99	31.70	16.38	31.31
7500.00	15.43	32.29	15.99	31.73	16.39	31.33
7525.00	15.44	32.31	16.00	31.75	16.40	31.35
7550.00	15.43	32.35	16.02	31.76	16.41	31.37
7575.00	15.45	32.36	16.03	31.78	16.42	31.38
7600.00	15.48	32.36	16.04	31.79	16.43	31.40
7625.00	15.46	32.40	16.05	31.82	16.44	31.42
7650.00	15.41	32.48	16.05	31.84	16.44	31.46
7675.00	15.41	32.51	16.05	31.87	16.43	31.49
7700.00	15.43	32.52	16.04	31.91	16.41	31.54

Frequency	Gain(Isotr.) 1 m Apert.	Ant.-Factor 1 m Apert.	Gain(Isotr.) 3 m Apert.	Ant.-Factor 3 m Apert.	Gain(Isotr.) Farfield	Ant.-Factor Farfield
MHz	dBi	dB/m	dBi	dB/m	dBi	dB/m
7725.00	15.39	32.59	16.01	31.97	16.39	31.59
7750.00	15.31	32.69	15.98	32.03	16.36	31.65
7775.00	15.30	32.74	15.95	32.09	16.32	31.71
7800.00	15.31	32.75	15.92	32.15	16.30	31.77
7825.00	15.29	32.80	15.89	32.20	16.28	31.81
7850.00	15.24	32.88	15.88	32.24	16.27	31.85
7875.00	15.24	32.90	15.87	32.28	16.26	31.89
7900.00	15.27	32.90	15.87	32.30	16.26	31.91
7925.00	15.28	32.92	15.87	32.33	16.28	31.92
7950.00	15.27	32.95	15.89	32.34	16.29	31.93
7975.00	15.29	32.96	15.89	32.36	16.31	31.95
8000.00	15.29	32.99	15.90	32.38	16.32	31.96
8025.00	15.27	33.04	15.92	32.39	16.34	31.97
8050.00	15.29	33.04	15.92	32.41	16.34	31.99
8075.00	15.30	33.06	15.95	32.42	16.36	32.01
8100.00	15.27	33.11	15.96	32.43	16.36	32.03
8125.00	15.27	33.15	15.98	32.43	16.37	32.05
8150.00	15.34	33.10	16.02	32.42	16.40	32.04
8175.00	15.39	33.07	16.05	32.42	16.43	32.04
8200.00	15.41	33.09	16.09	32.40	16.48	32.01
8225.00	15.43	33.09	16.14	32.38	16.53	31.99
8250.00	15.53	33.02	16.19	32.36	16.58	31.97
8275.00	15.59	32.98	16.24	32.33	16.62	31.95
8300.00	15.59	33.01	16.27	32.33	16.66	31.94
8325.00	15.59	33.04	16.30	32.33	16.68	31.95
8350.00	15.65	33.01	16.32	32.34	16.70	31.96
8375.00	15.66	33.02	16.31	32.37	16.70	31.98
8400.00	15.61	33.10	16.29	32.41	16.69	32.02
8425.00	15.59	33.14	16.28	32.45	16.68	32.05
8450.00	15.61	33.15	16.26	32.50	16.66	32.10
8475.00	15.57	33.21	16.25	32.53	16.64	32.14
8500.00	15.52	33.29	16.22	32.59	16.61	32.20
8525.00	15.52	33.31	16.19	32.64	16.59	32.24
8550.00	15.52	33.34	16.16	32.70	16.57	32.29
8575.00	15.47	33.41	16.14	32.74	16.55	32.34
8600.00	15.44	33.47	16.12	32.79	16.53	32.38
8625.00	15.49	33.45	16.11	32.83	16.52	32.41
8650.00	15.51	33.46	16.11	32.85	16.53	32.43
8675.00	15.48	33.51	16.12	32.87	16.54	32.44
8700.00	15.50	33.51	16.14	32.87	16.56	32.45
8725.00	15.63	33.40	16.20	32.84	16.60	32.44
8750.00	15.73	33.33	16.26	32.80	16.67	32.39
8775.00	15.78	33.30	16.35	32.74	16.73	32.35
8800.00	15.91	33.20	16.43	32.68	16.83	32.28
8825.00	16.10	33.04	16.55	32.59	16.93	32.21
8850.00	16.24	32.91	16.66	32.50	17.05	32.11
8875.00	16.36	32.83	16.78	32.40	17.17	32.01
8900.00	16.50	32.70	16.92	32.29	17.29	31.92
8925.00	16.66	32.57	17.03	32.20	17.41	31.82
8950.00	16.81	32.44	17.15	32.10	17.54	31.72
8975.00	16.94	32.34	17.28	32.00	17.66	31.62
9000.00	17.07	32.23	17.39	31.91	17.79	31.51
9025.00	17.21	32.12	17.52	31.80	17.92	31.41
9050.00	17.36	32.00	17.66	31.70	18.05	31.30

Frequency	Gain(Isotr.) 1 m Apert.	Ant.-Factor 1 m Apert.	Gain(Isotr.) 3 m Apert.	Ant.-Factor 3 m Apert.	Gain(Isotr.) Farfield	Ant.-Factor Farfield
MHz	dBi	dB/m	dBi	dB/m	dBi	dB/m
9075.00	17.51	31.87	17.81	31.57	18.20	31.18
9100.00	17.68	31.72	17.98	31.42	18.37	31.03
9125.00	17.85	31.57	18.16	31.27	18.55	30.87
9150.00	18.03	31.42	18.36	31.09	18.76	30.69
9175.00	18.23	31.24	18.58	30.89	18.97	30.50
9200.00	18.44	31.05	18.80	30.70	19.19	30.30
9225.00	18.63	30.89	19.03	30.49	19.42	30.10
9250.00	18.79	30.75	19.25	30.29	19.64	29.90
9275.00	18.95	30.61	19.44	30.12	19.83	29.73
9300.00	19.10	30.49	19.63	29.96	20.01	29.58
9325.00	19.19	30.42	19.77	29.84	20.16	29.45
9350.00	19.24	30.40	19.88	29.75	20.26	29.37
9375.00	19.27	30.39	19.96	29.70	20.34	29.32
9400.00	19.28	30.41	20.00	29.68	20.38	29.31
9425.00	19.23	30.47	20.00	29.71	20.37	29.33
9450.00	19.17	30.56	19.98	29.75	20.35	29.37
9475.00	19.09	30.67	19.93	29.82	20.31	29.44
9500.00	18.99	30.78	19.87	29.90	20.24	29.53
9525.00	18.90	30.90	19.80	30.00	20.17	29.63
9550.00	18.78	31.04	19.72	30.10	20.09	29.73
9575.00	18.67	31.17	19.63	30.21	20.00	29.84
9600.00	18.55	31.31	19.55	30.31	19.91	29.95
9625.00	18.42	31.46	19.46	30.42	19.82	30.07
9650.00	18.29	31.62	19.36	30.55	19.72	30.19
9675.00	18.16	31.77	19.24	30.69	19.61	30.33
9700.00	18.01	31.94	19.13	30.83	19.49	30.46
9725.00	17.84	32.14	18.99	30.99	19.36	30.62
9750.00	17.68	32.32	18.85	31.15	19.22	30.78
9775.00	17.53	32.49	18.71	31.31	19.08	30.94
9800.00	17.36	32.68	18.56	31.49	18.93	31.12
9825.00	17.19	32.88	18.42	31.65	18.78	31.29
9850.00	17.01	33.08	18.27	31.82	18.63	31.46
9875.00	16.84	33.27	18.11	32.00	18.46	31.65
9900.00	16.68	33.45	17.97	32.17	18.32	31.81
9925.00	16.49	33.67	17.82	32.34	18.17	31.99
9950.00	16.29	33.88	17.66	32.52	18.01	32.17
9975.00	16.11	34.09	17.49	32.71	17.84	32.36
10000.00	15.90	34.32	17.30	32.92	17.65	32.57
10025.00	15.68	34.56	17.13	33.11	17.47	32.78
10050.00	15.46	34.81	16.95	33.31	17.29	32.97
10075.00	15.22	35.07	16.76	33.53	17.09	33.20
10100.00	14.97	35.34	16.55	33.76	16.89	33.42
10125.00	14.72	35.61	16.34	33.99	16.67	33.66
10150.00	14.44	35.91	16.11	34.24	16.44	33.91
10175.00	14.15	36.23	15.88	34.49	16.21	34.16
10200.00	13.82	36.57	15.62	34.77	15.95	34.44
10225.00	13.49	36.92	15.32	35.09	15.64	34.77
10250.00	13.13	37.31	14.99	35.44	15.30	35.13
10275.00	12.70	37.75	14.64	35.81	14.93	35.52
10300.00	12.19	38.29	14.23	36.25	14.53	35.95
10325.00	11.68	38.81	13.80	36.69	14.08	36.42
10350.00	11.45	39.06	13.57	36.95	13.83	36.69
10375.00	11.10	39.43	13.31	37.23	13.57	36.97
10400.00	10.71	39.85	13.05	37.51	13.30	37.26

Erzeugung definierter Feldstärken BBHA 9120 B Generating defined Field Strength BBHA 9120 B 1 - 10 GHz

Erzeugung von Feldstärken unter Freiraumbedingungen vor der Aperturöffnung der Hornantenne (siehe Skizze und Angaben bei den Kurvenscharen). Wenn Anteile von Umgebungsreflexionen vorhanden sind, kann dies zu einer frequenz- und höhenabhängigen Änderung der Feldstärke führen. Die Leistungsangaben beziehen sich auf eine 50 Ω Quellimpedanz und unmodulierte Hochfrequenz (CW). Bei 80% Amplitudenmodulation ist die 1.8-fache Spannungssteuerung erforderlich, was in einem ca. 3.24-fachen Leistungsbedarf resultiert. Zur Steigerung der Feldstärke um den Faktor 10 ist die 100-fache Verstärkerleistung erforderlich.

Bei der Erzeugung von hohen Feldstärken müssen die relevanten Sicherheitsvorschriften und Normen beachtet werden! Missachtung dieser Vorschriften kann zu Schädigungen der Gesundheit führen!

Field strength generated under free-space conditions at a separation from the antenna aperture (see diagrams for several combinations of power and distance). If environmental reflections are present, this may lead to frequency and height dependent field strengths. The power figures refer to a 50 Ω source and an unmodulated (cw) signal. An 80% Amplitude Modulation requires a 1.8 times higher voltage, resulting in 3.24 times higher power compared to cw. A fieldstrength increase of factor 10 requires 100 times amplifier-power.

The safety precautions and relevant standards must be considered while performing tests with high field-strength! Ignoring these standards and precautions may result in severe danger for health!

Modulation (AM)	50 %	60 %	70 %	80 %	90 %	95%	Modulation (AM)
Leistungsfaktor	2.25	2.56	2.89	3.24	3.61	3.8	Power Factor
Zusätzlicher Leistungsbedarf [dB]	+3.5	+4.1	+4.6	+5.1	+5.6	+5.8	Additional Power Requirement [dB]

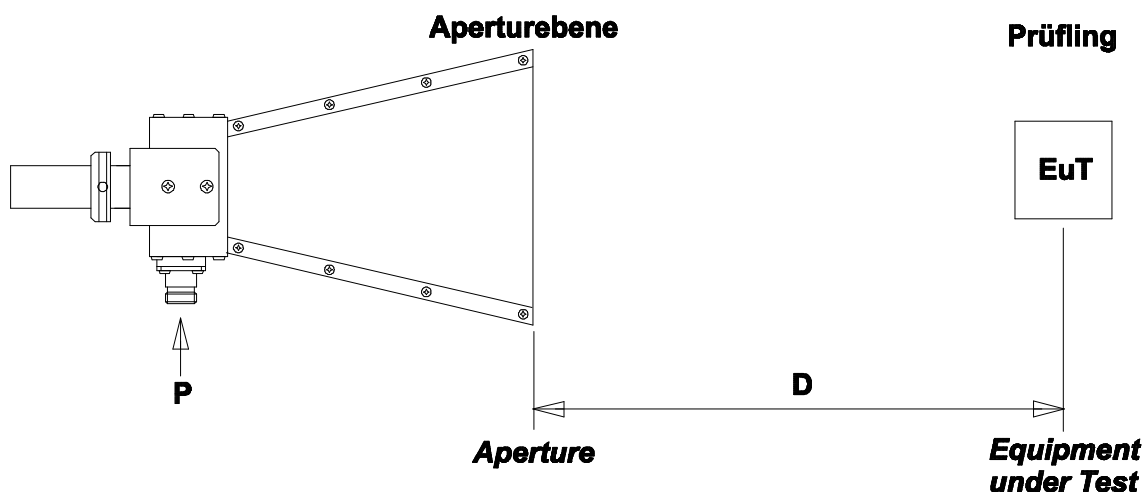



e

Erzeugte elektrische Feldstärke vor der Antennenspitze
unmoduliert, Eingangsleistung an N-Buchse, Reflexionsfreie Umgebung
Generated electrical Fieldstrength in front of Antenna Tip
no modulation, Input Power at N-Connector, Anechoic Environmental Conditions

BBHA 9120 B Input Power, Dist. Aperture-EuT: 1 m

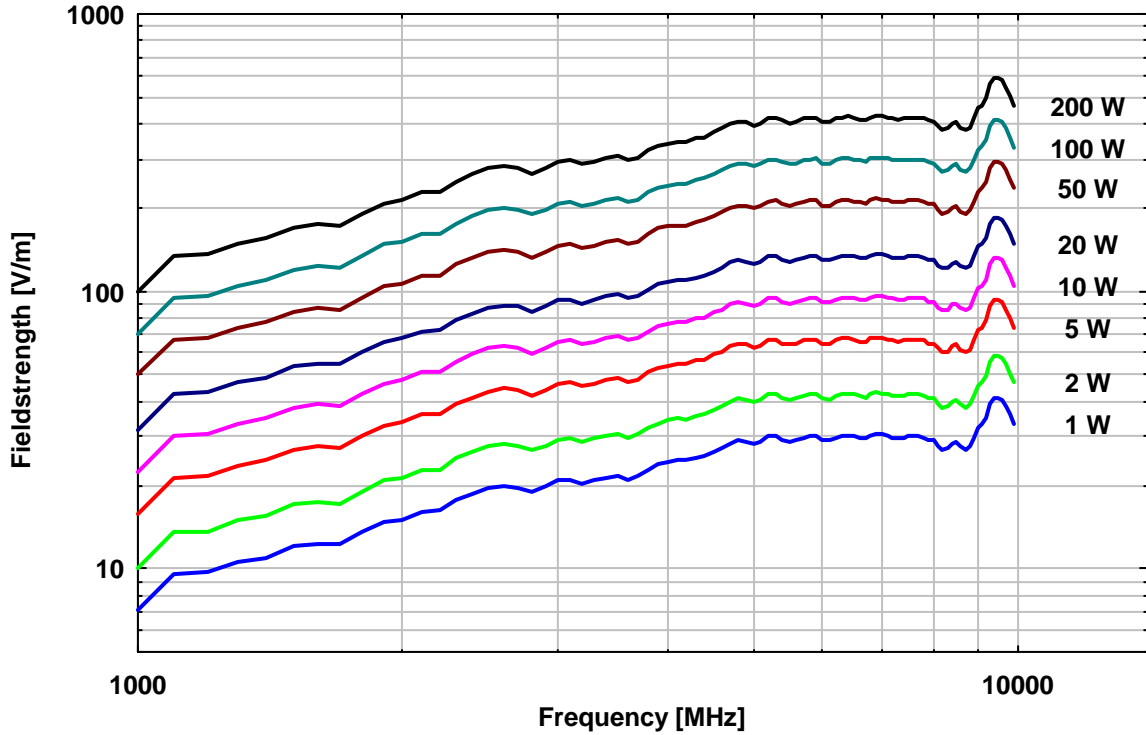

BBHA 9120 B Input Power, Dist. Aperture-EuT: 2 m

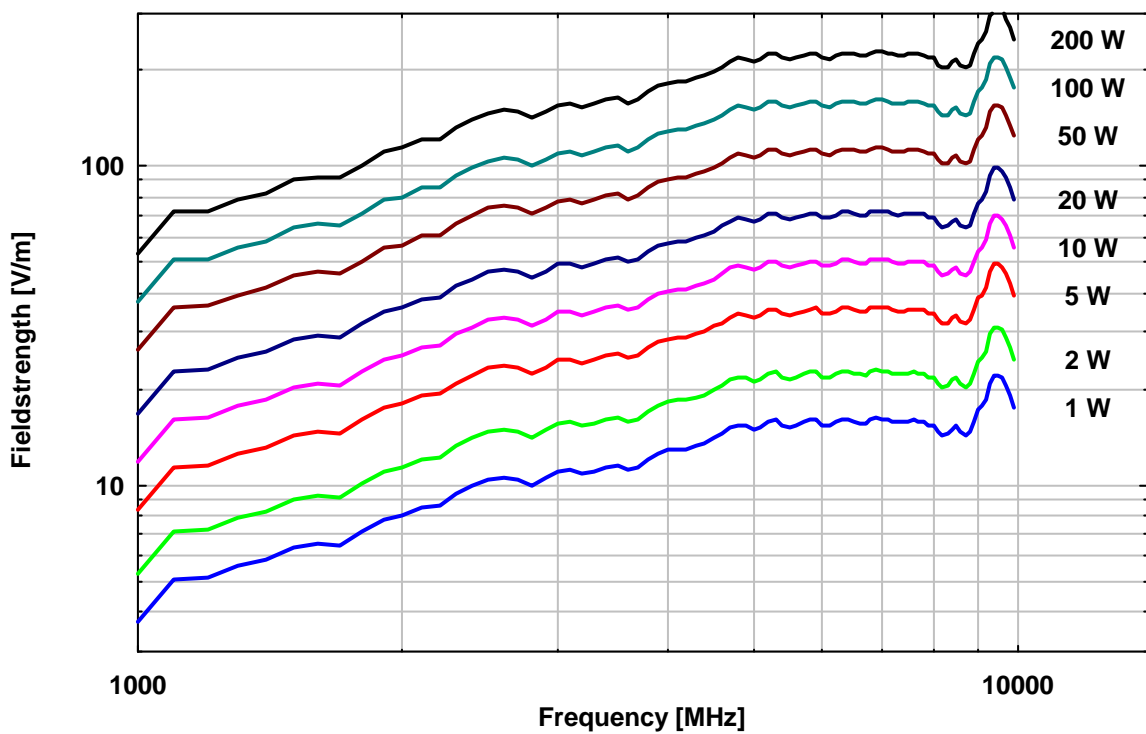



BBHA 9120 B Input Power, Dist. Aperture-EuT: 3 m

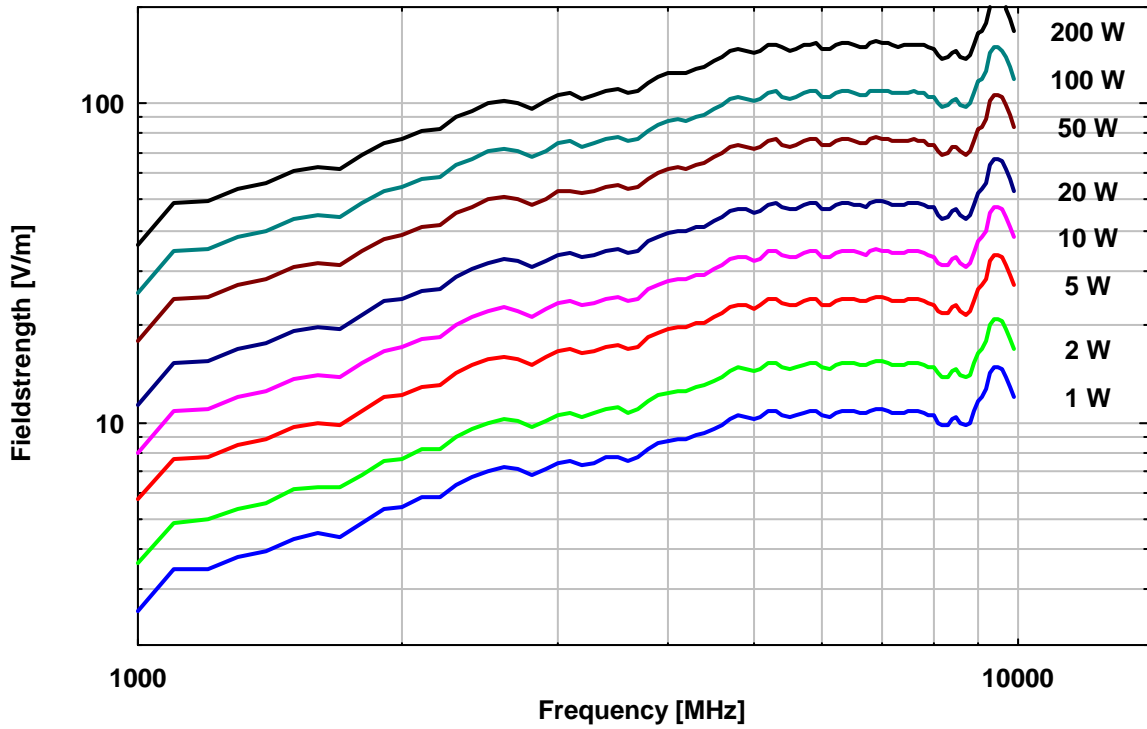

BBHA 9120 B Input Power, Dist. Aperture-EuT: 4 m

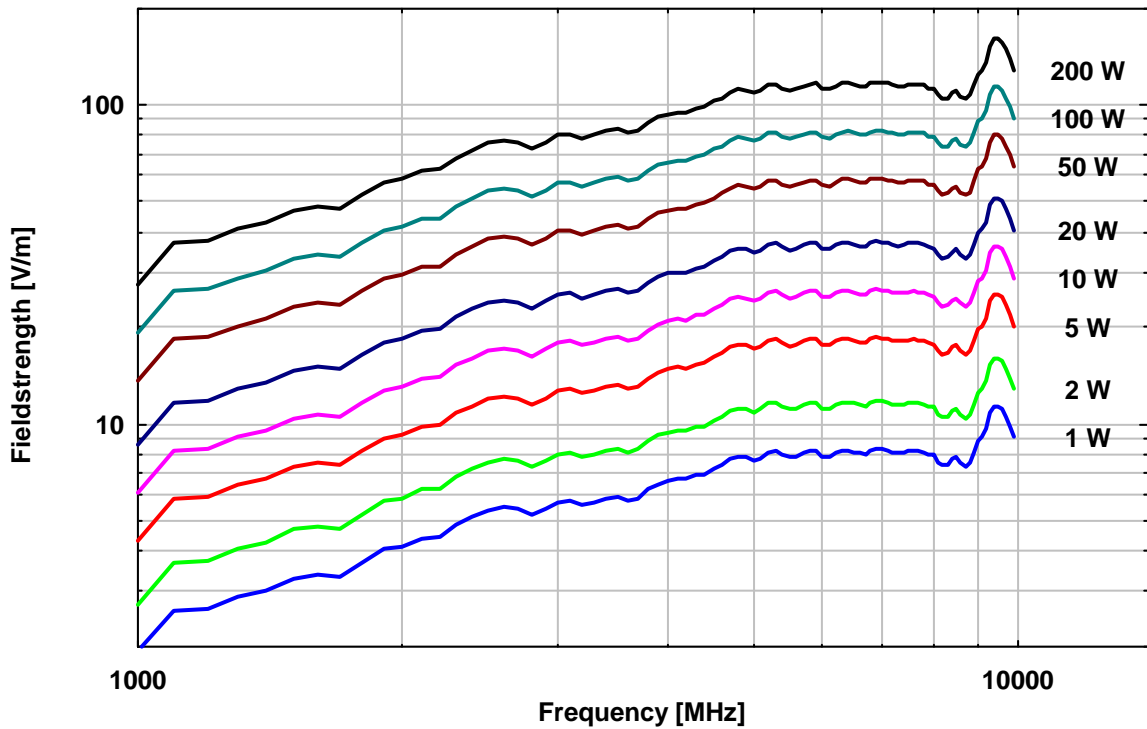



Stehwellenverhältnis

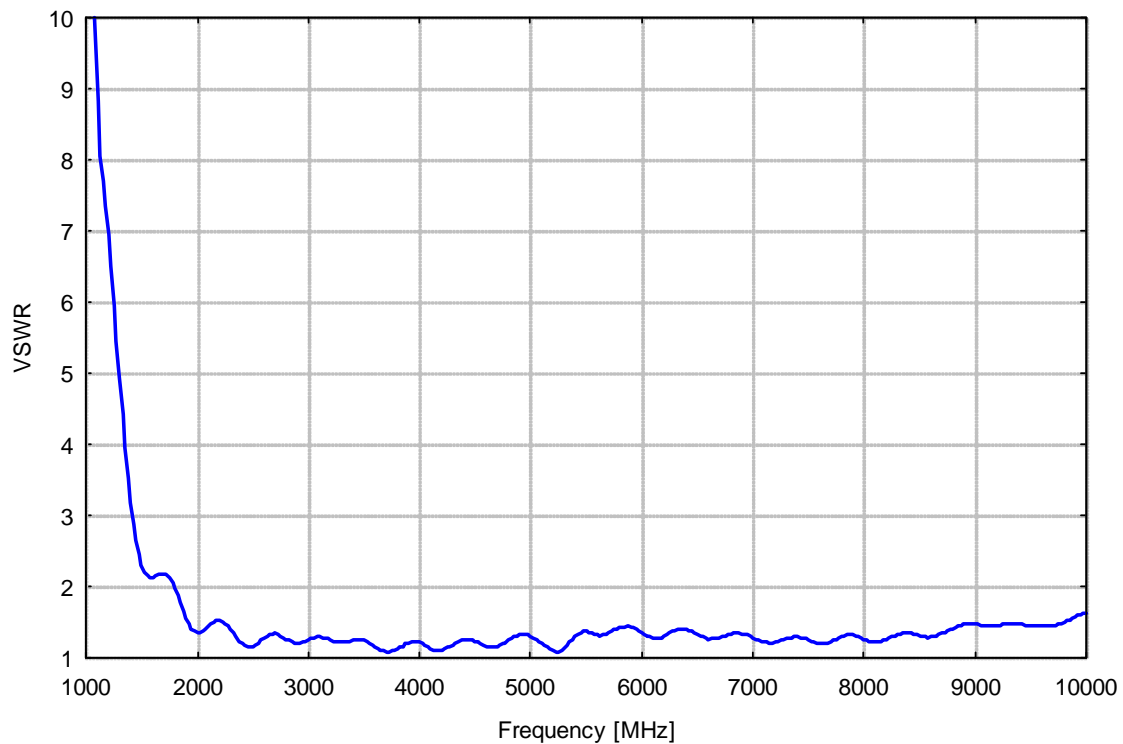

Maximale Eingangsleistung

