



Custom **production**
of health **supplements**

neopharma

PRODUCT CATALOGUE

Obsah

1. Blistry	3
Legenda tvarů	4
Formát řada 1–2	4
Formát řada 3	5
Formát řada 4	6
Formát řada 5	7
Formát řada 6	9
2. Sachety, sticky, doypacky	10
Sachety	11
Sticky	12
Doypacky	13
3. Kapsle, tablety	14
Tvary a rozměry	
4. Dózy pevné formy	20
PET	21
HDPE	24
4. Lahve tekuté formy, shrink sleeve technologie	28
PET shoty a lahve	29
technologie Shrink sleeve	31

1. Blistry

Tvary, rozměry a obsah

Formát/1

124 × 75 mm

20 ks

hloubka kavity: 7,60 mm

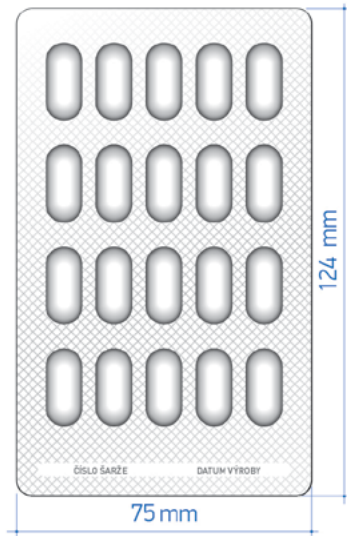

 21,50 × 10,00 mm



Formát 2/1

195 × 100 mm

21/21 ks

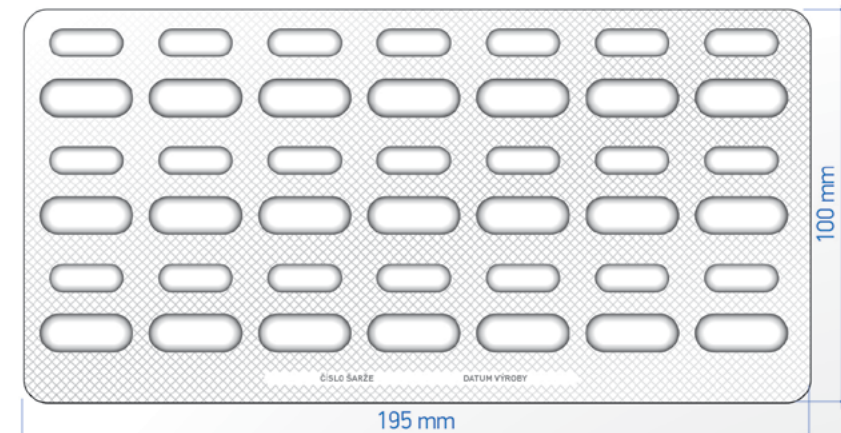
hloubka kavity: 7,00; 8,60 mm



 21,70 × 7,65 mm
 15,90 × 5,82 mm

Legenda tvarů:



kapsle



pastilka



softgel



tableta oblong



tableta oblong
breakline



tableta čočka



tableta čočka
breakline

formát řada 1, 2 a 3

Formát 3/1

130 × 100 mm 20 ks

hloubka kavity: 8,80; 11,00 mm

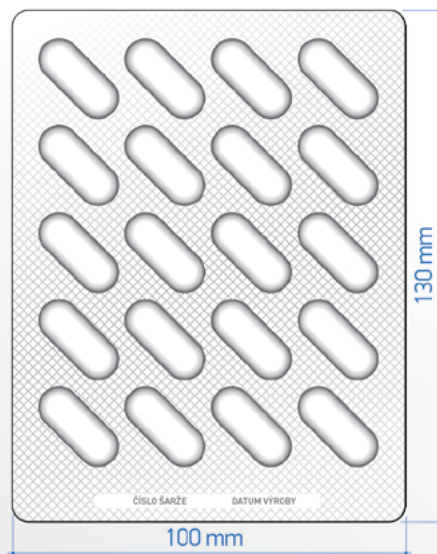



 23,30 × 8,53 mm

Formát 3/2

130 × 100 mm 20 ks

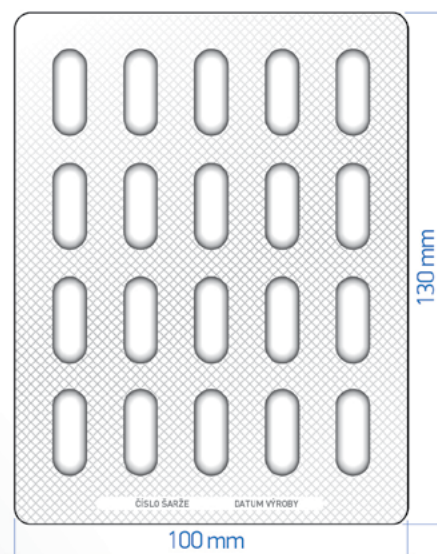
hloubka kavity: 9,00; 9,25 mm





 21,70 × 7,65 mm

Formát 3/3

130 × 100 mm 15 ks

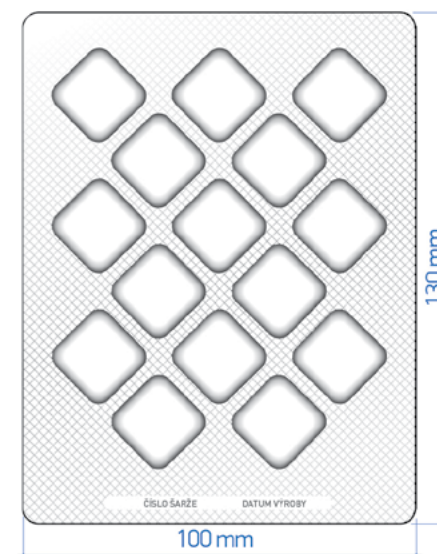
hloubka kavity: 10,70 mm



 19,3 × 9,9 × 19,3 mm

Blistry tablety / kapsle / pastilky

Formát 4/1

110×80mm 15 ks

hloubka kavity: 9,40mm

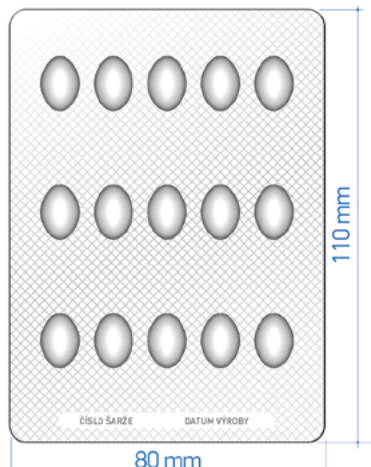

⊖ 14,00×10,00 mm

Formát 4/2

110×80mm 15 ks

hloubka kavity: 7,90mm



⊖ 19,40×6,91 mm

Formát 4/3

110×80mm 15 ks

hloubka kavity: 7,90; 8,20mm

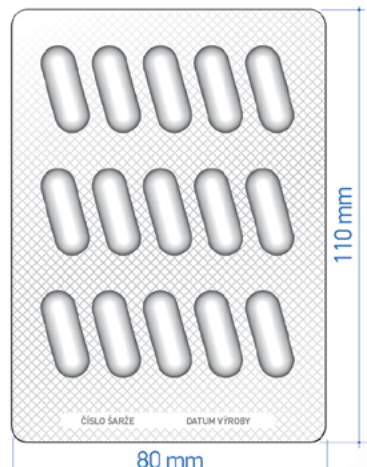

⊖ 21,70×7,65 mm

Formát 4/4

110×80mm 15 ks

hloubka kavity: 12,00mm

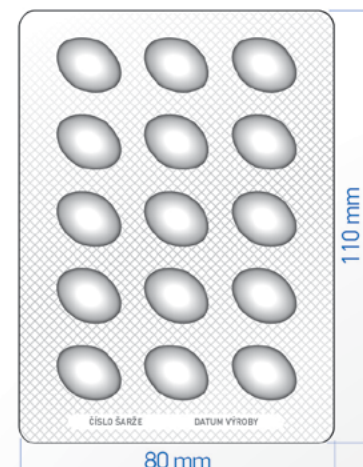

⊖ 13,00×18,00×12,00 mm

Formát 4/5

110×80mm 20 ks

hloubka kavity: 9,00mm

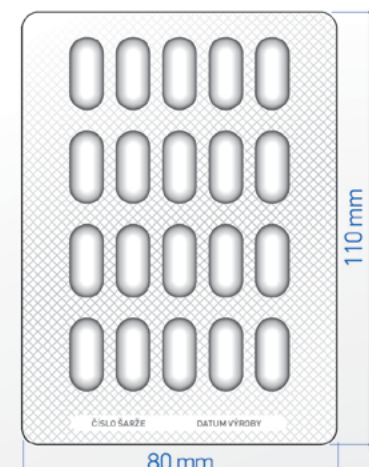

⊖ 10,00×23,00 mm

Formát 4/6

110×80mm 10 ks

hloubka kavity: 9,55mm

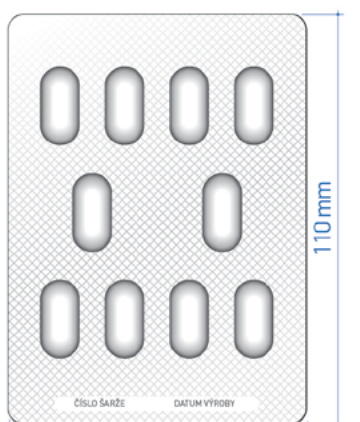

⊖ 19,20×8,00 mm

Formát 4/7

110×80mm 20 ks

hloubka kavity: 8,10mm

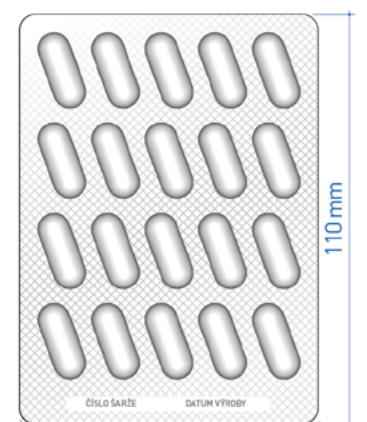

⊖ 19,40×6,91 mm

Formát 4/8

110×80mm 15 ks

hloubka kavity: 9,15mm

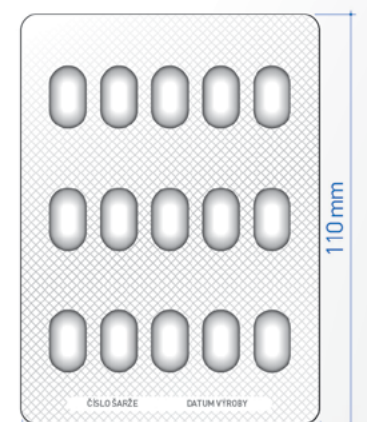

⊖ 17,00×10,00 mm

Formát 4/9

110×80mm 15 ks

hloubka kavity: 8,20mm

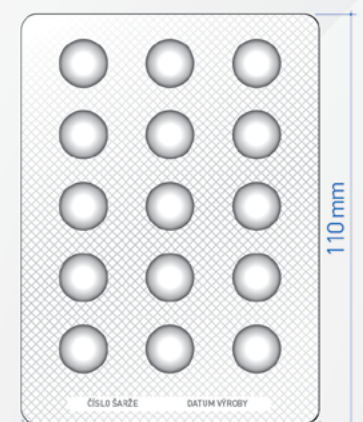

⊖ ∅ 12,50 mm

Formát 4/10

110×80mm 20 ks

hloubka kavity: 6,70mm

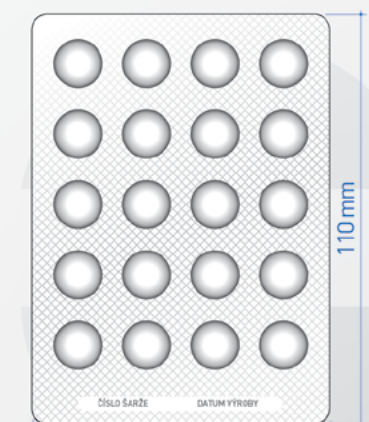



⊖ ∅ 12,00 mm

formát řada 4 a 5

Formát 4/11

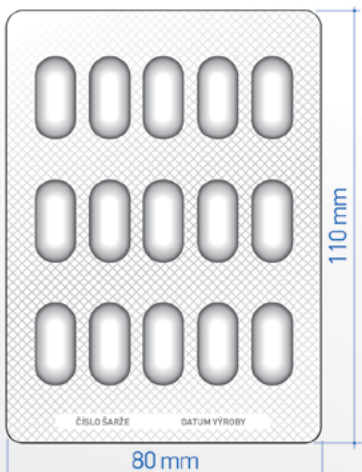
110×80mm 15 ks
hloubka kavity: 8,25mm



 19,20×8,00 mm

Formát 4/12

110×80mm 15 ks
hloubka kavity: 6,70; 8,20mm

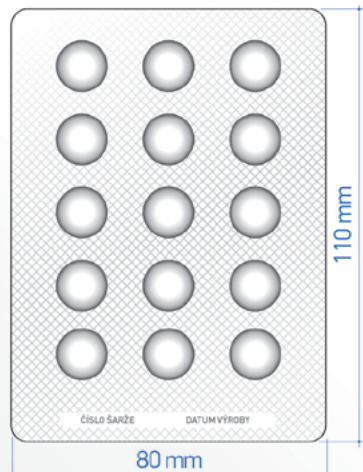

 Ø 12,00 mm

Formát 4/13

110×80mm 30 ks
hloubka kavity: 5,80mm

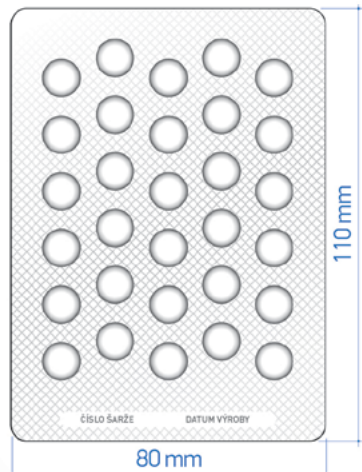

 Ø 9,00 mm

Formát 4/14

110×80mm 15 ks
hloubka kavity: 9,90mm

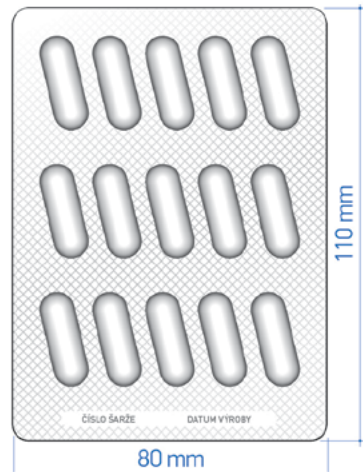

 23,30×8,53 mm

Formát 4/15

110×80mm 20 ks
hloubka kavity: 8,15mm

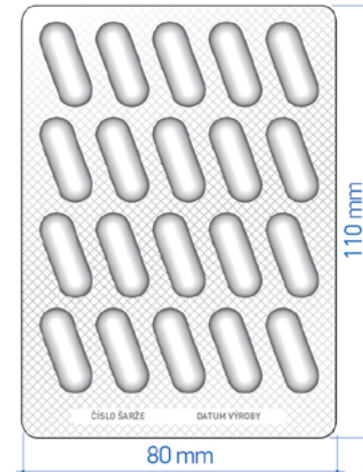



 19,40×6,91 mm

Formát 4/16

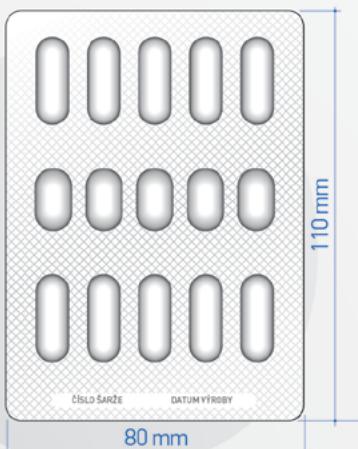
110×80mm 10/5 ks
hloubka kavity: 9,15mm



 23,30×8,53 mm
 17,00×10,00 mm

Formát 4/17

110×80mm 15 ks
hloubka kavity: 9,90mm

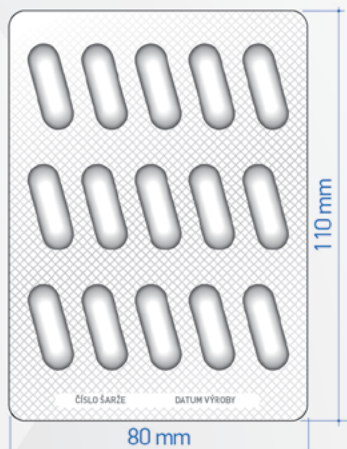

 23,45×8,50 mm

Formát 5/1

87×59mm 10 ks
hloubka kavity: 9,90mm

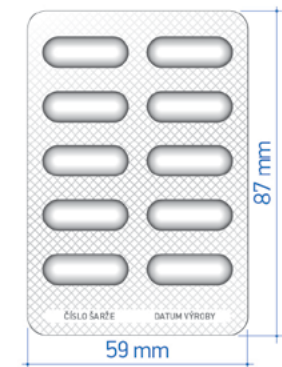

 23,30×8,53 mm

Blistry tablety / kapsle / pastilky

Formát 5/2

87×59 mm 10 ks
hloubka kavity: 9,90 mm

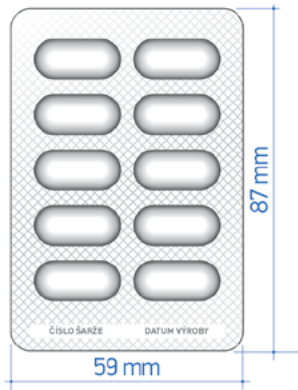

 21,20 × 8,00 mm

Formát 5/3

87×59 mm 15 ks
hloubka kavity: 5,50 mm

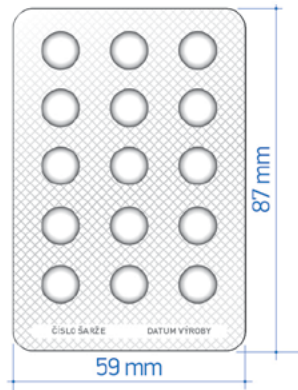

 Ø 9,00 mm

Formát 5/4

87×59 mm 10 ks
hloubka kavity: 6,60 mm

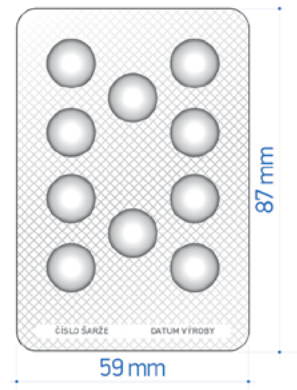

 Ø 12,00 mm

Formát 5/5

87×59 mm 10 ks
hloubka kavity: 7,04 mm



 15,90 × 5,82 mm

Formát 5/6

87×59 mm 15 ks
hloubka kavity: 6,87 mm



 15,90 × 5,82 mm

Formát 5/7

87×59 mm 10 ks
hloubka kavity: 7,50; 8,05 mm

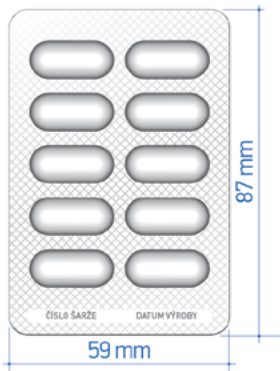

 21,70 × 7,65 mm

Formát 5/8

87×59 mm 10 ks
hloubka kavity: 6,04 mm

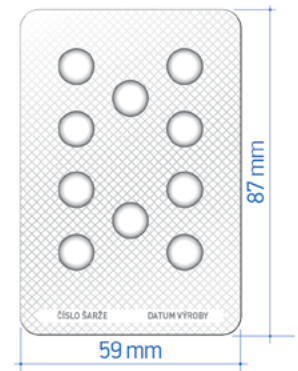

 Ø 9,00 mm

Formát 5/9

87×59 mm 10 ks
hloubka kavity: 9,30 mm

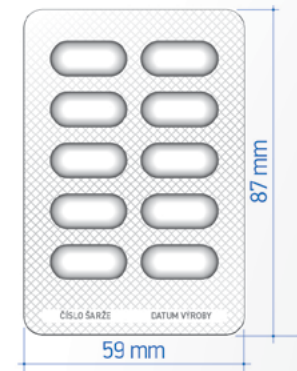

 21,20 × 8,00 mm

Formát 5/10

87×59 mm 10 ks
hloubka kavity: 6,28 mm

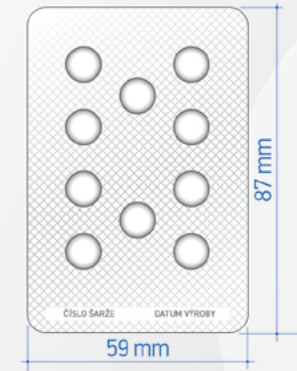

 Ø 9,00 mm

Formát 5/11

87×59 mm 10 ks
hloubka kavity: 7,95 mm



 Ø 12,00 mm

formát řada 5 a 6

Formát 5/12

87×59mm 10 ks
hloubka kavity: 7,50; 9,35; 9,70mm

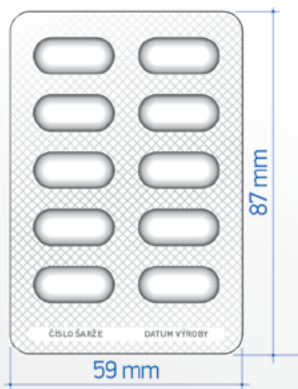

19,20×8,00 mm

Formát 5/13

87×59mm 10 ks
hloubka kavity: 9,40mm



∅ 12,00 mm

Formát 5/14

87×59mm 8 ks
hloubka kavity: 10,00mm

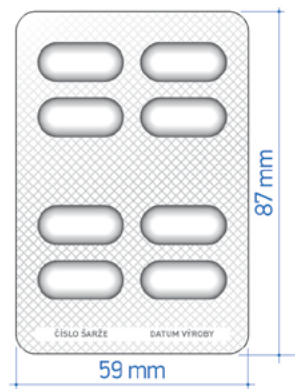

21,20×8,00 mm

Formát 5/15

87×59mm 4/2 ks
hloubka kavity: 6,50; 6,15mm

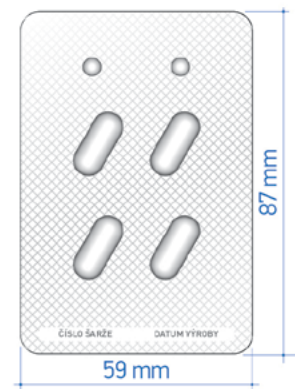

15,90×5,82 mm
∅ 4,80 mm

Formát 5/16

87×59mm 4 ks
hloubka kavity: 9,25mm

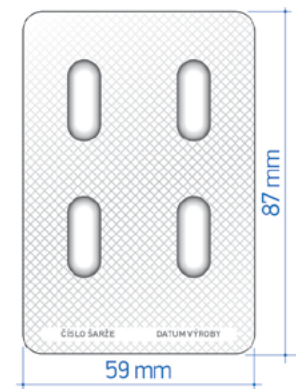

23,30×8,53 mm

Formát 6/1

92×38mm 4 ks
hloubka kavity: 8,00mm

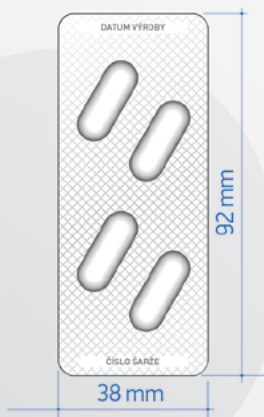

23,30×8,53 mm

Formát 6/2

92×38mm 10 ks
hloubka kavity: 6,86mm

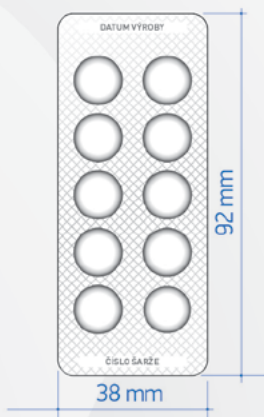

∅ 12,00 mm

Formát 6/3

92×38mm 10 ks
hloubka kavity: 6,50mm

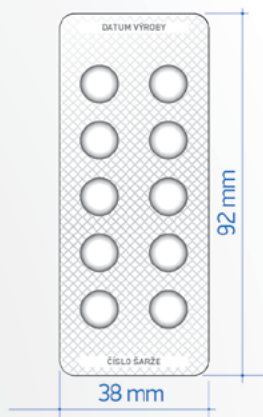

∅ 9,00 mm

Formát 6/4

92×38mm 10 ks
hloubka kavity: 6,00mm

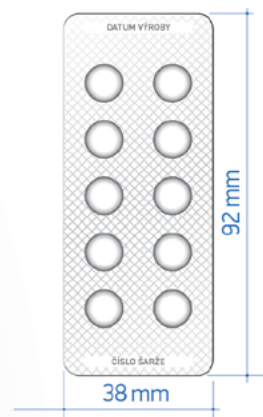

∅ 9,00 mm

Formát 6/5

92×38mm 10 ks
hloubka kavity: 6,06mm

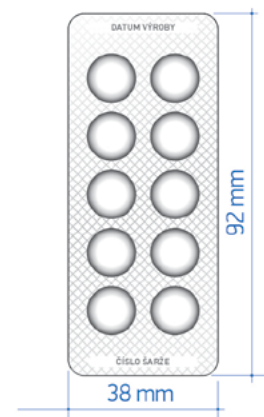

∅ 12,00 mm

Formát 6/6

92×38mm 4 ks
hloubka kavity: 8,00mm

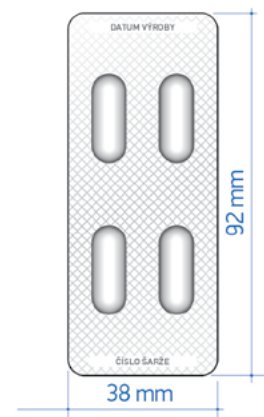

21,70×7,65 mm

2. Sachety, sticky, doypacky

Tvary, rozměry a obsah



Sachety

Sachet 1

min 50×60 mm

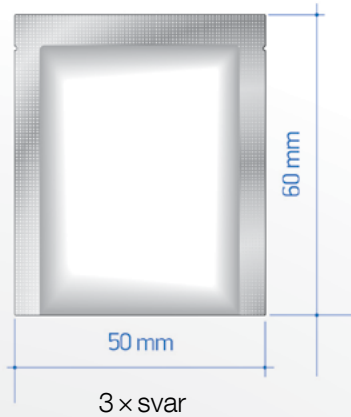

Sachet 1

min 50×60 mm

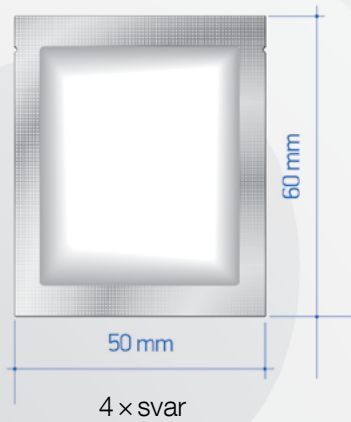

Sachet 2

max 130×180 mm

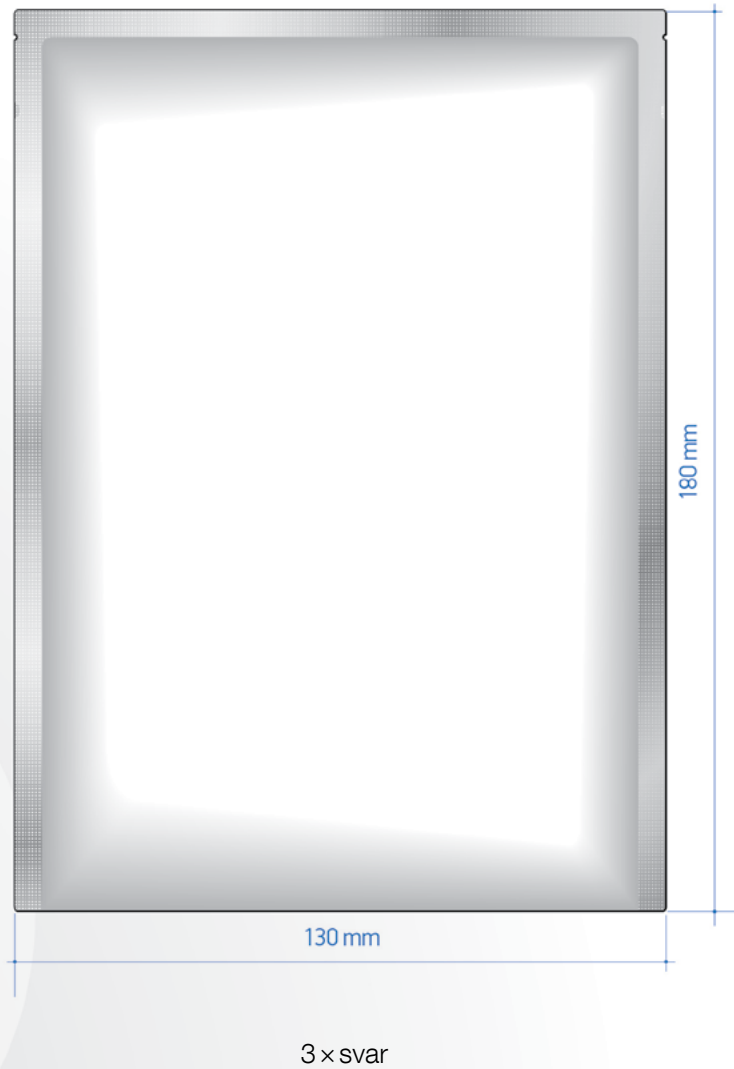

Sachet 2

max 130×180 mm



Stick 1

min 40×40 mm

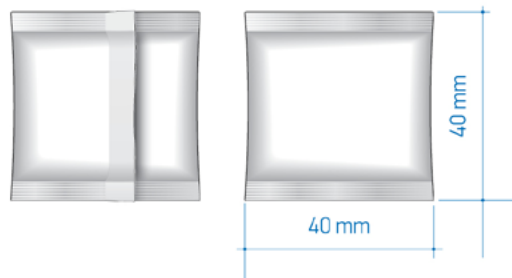

2 × svar 1 lepení

Stick 2

max 200×360 mm

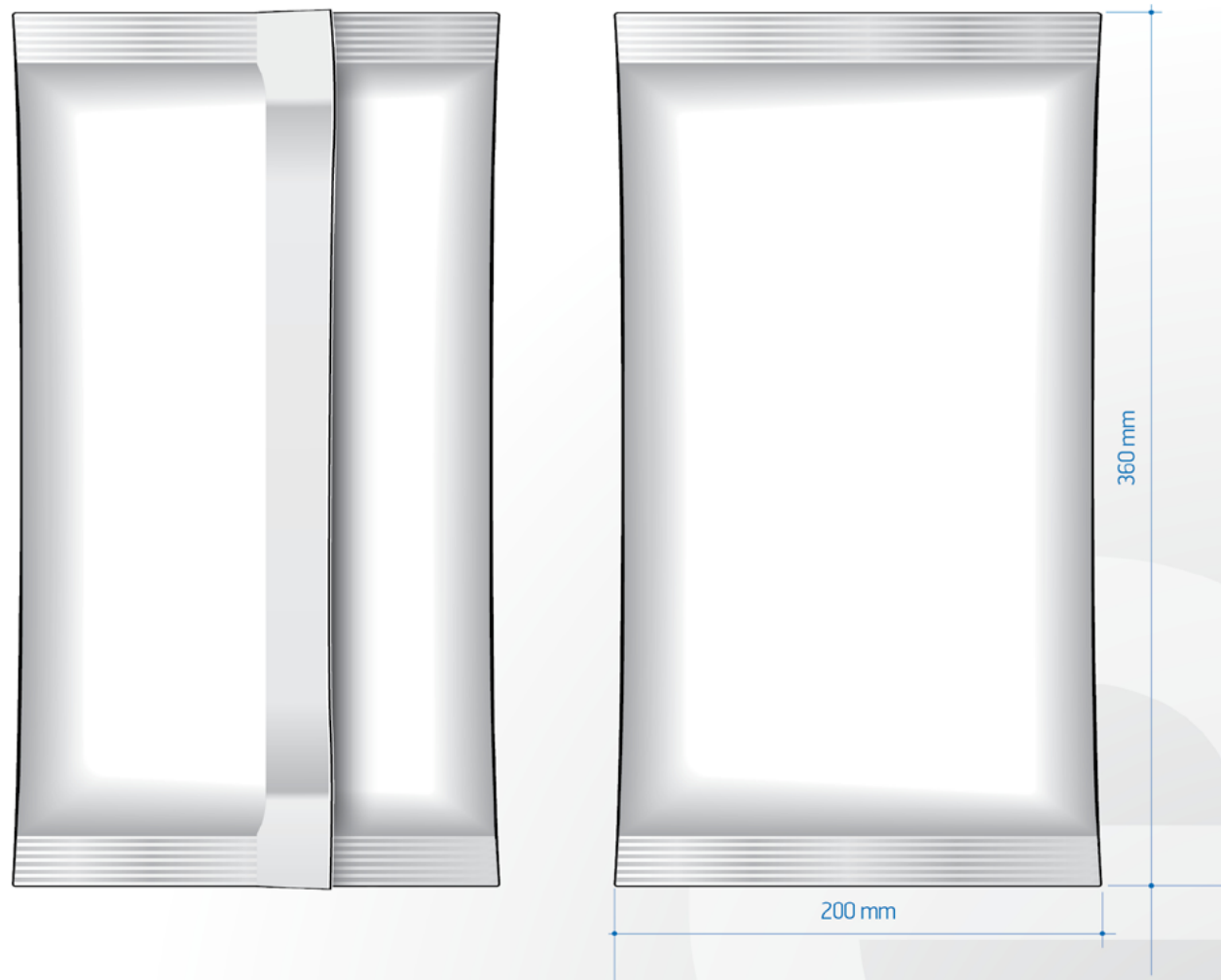

2 × svar 1 lepení

Doypack 1

130x180mm



Doypack 2

400x600mm



3. Kapsle, tablety

Tvary a rozměry



Kapsle

Kapsle 00

23,30×8,53mm

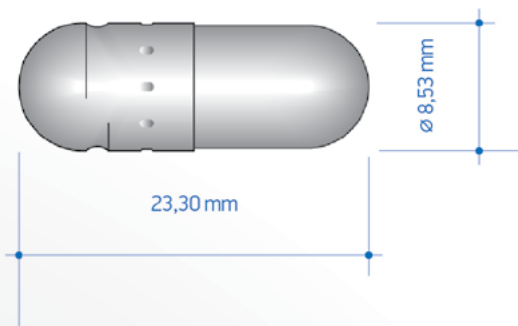

formáty 3/1, 4/14, 4/16, 5/1, 5/16, 6/1

Kapsle 0

21,70×7,65 mm

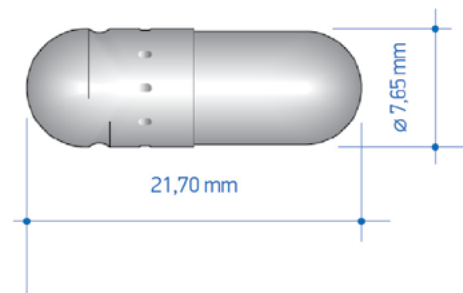

formáty 2/1, 3/2, 4/3, 5/7, 6/6

Kapsle 1

19,40×6,91 mm

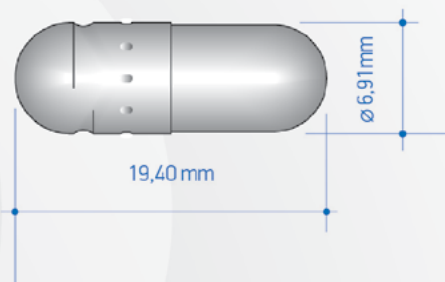

formáty 4/2, 4/7, 4/15

Kapsle 3

15,90×5,82 mm

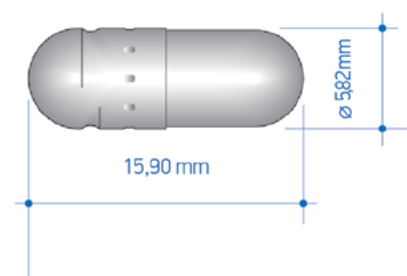

formáty 2/1, 5/5, 5/6, 5/15

Čočka 1

9,00mm breakline

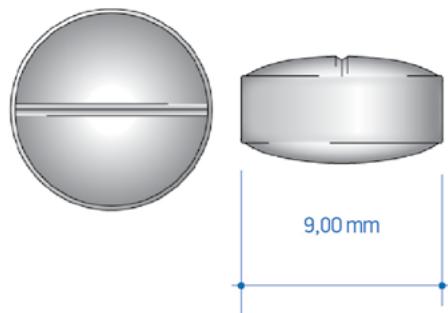

formáty 4/13, 5/3, 5/8, 5/10, 6/3, 6/4

Čočka 2

11,50mm

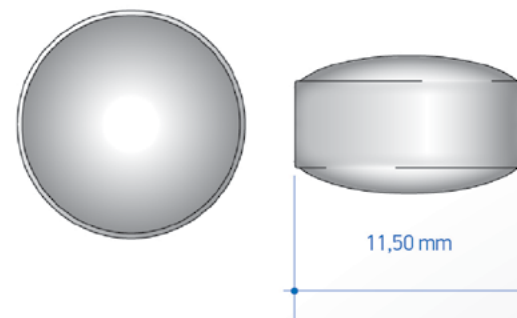

Čočka 3

12,00mm

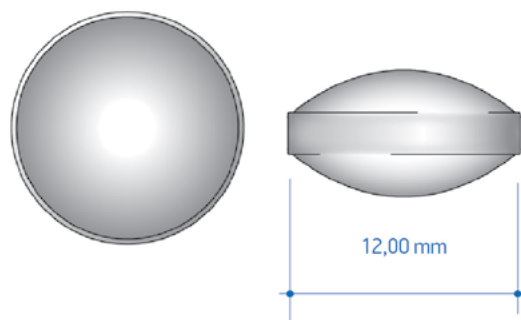

formáty 4/10, 4/12, 5/4, 5/11, 5/13, 6/2, 6/5

Čočka 4

12,50mm

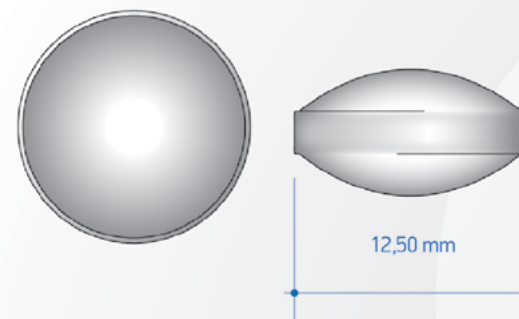

formát 4/9

Tablety oblong

Oblong 1

19,20 × 8,00 mm breakline

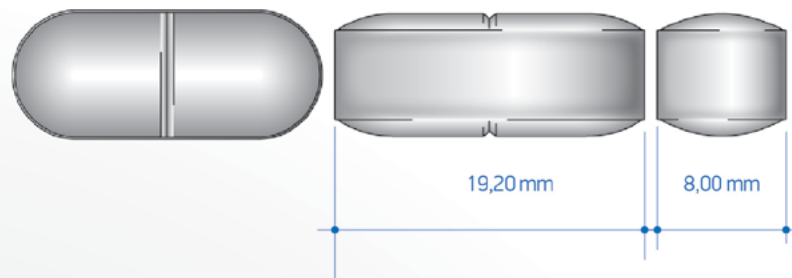

formáty 4/6, 4/11, 5/12

Oblong 2

21,20 × 8,00 mm

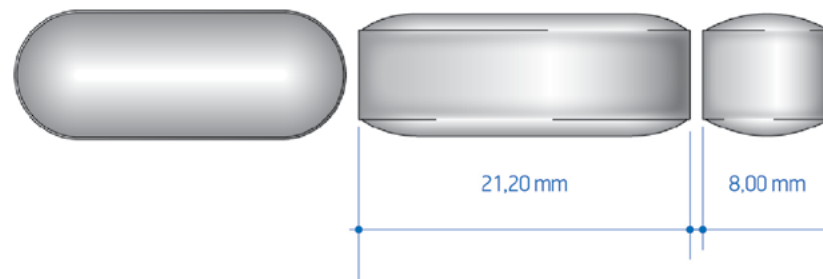

formáty 5/2, 5/9, 5/14

Oblong 3

23,45 × 8,50 mm breakline

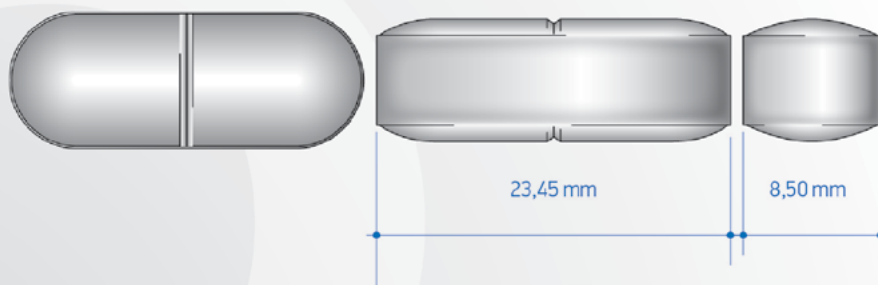

formát 4/17

Oblong 4

17,00 × 10,00 mm

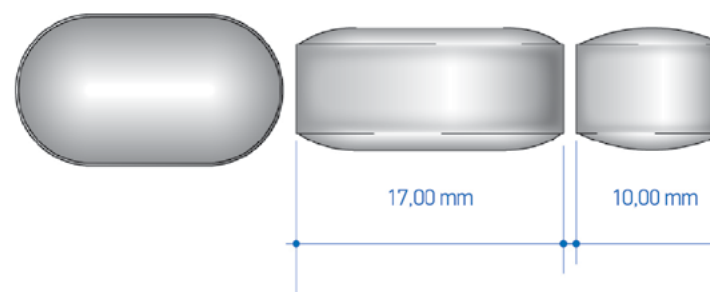

formát 4/16

Oblong 5

21,50 × 10,00 mm

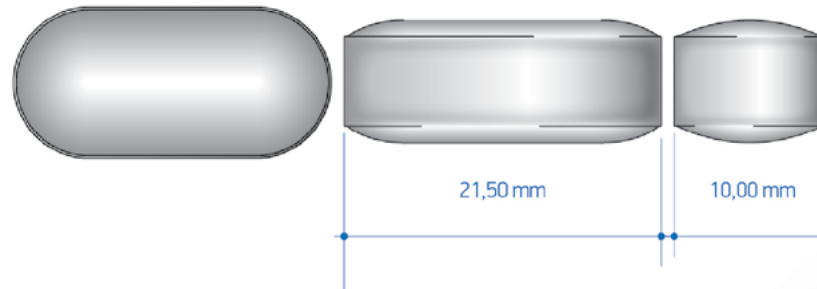

formát 1/1

Ovál 1

16,00 × 9,00 mm

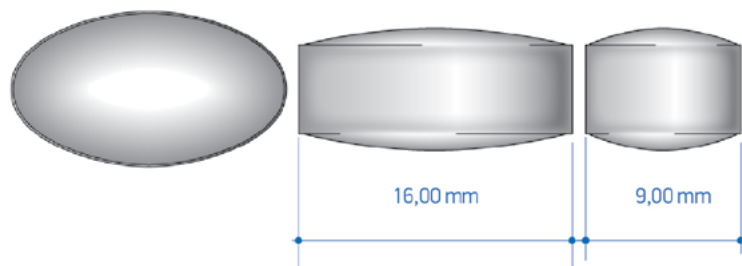

Ovál 2

25,20 × 12,00 mm breakline

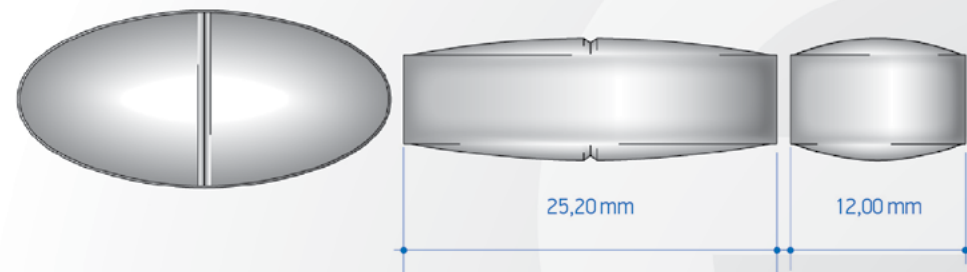

Tablety ovál a fazeta

Ovál 3

16,60×9,40mm

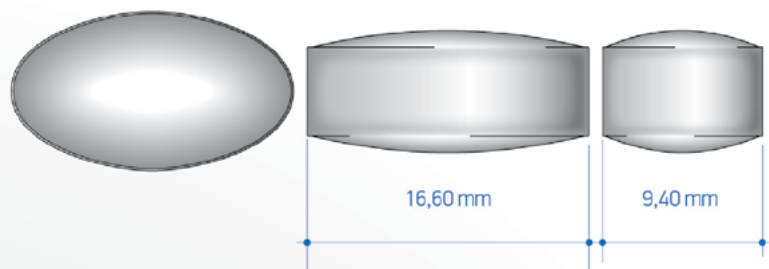

Ovál 4

21,00×10,00mm

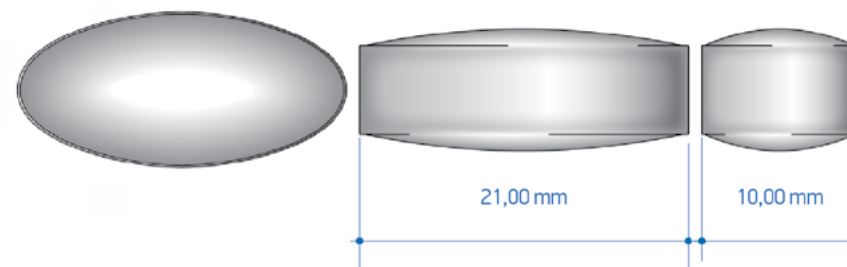

Fazeta

19,00×13,00mm

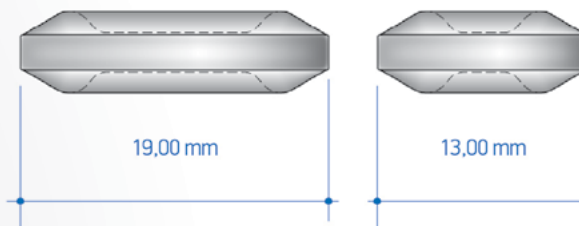

4. Dózy pevné formy

Nejčastější tvary a rozměry

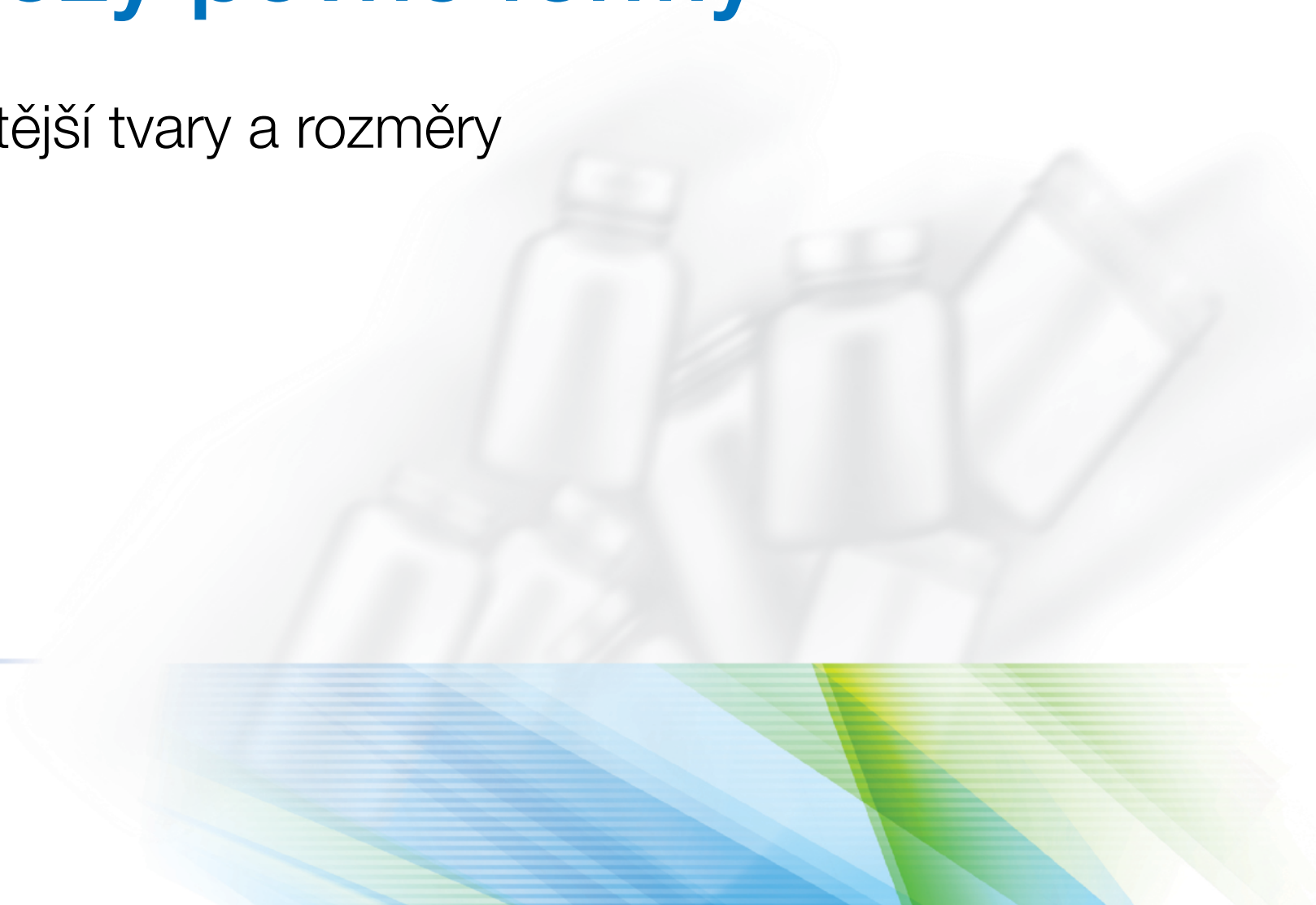

PET dózy

Dóza 75 ml

Ø 45,00 × 78,00 mm

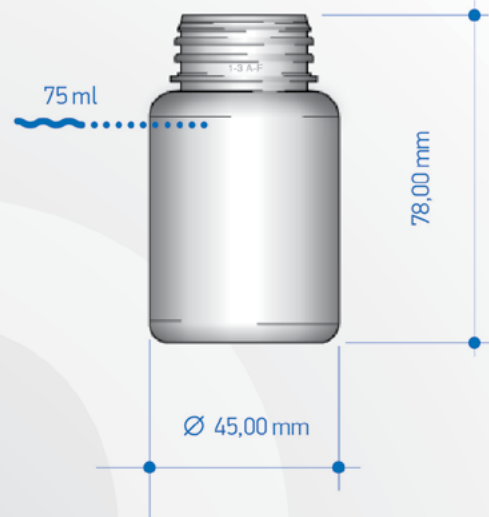

Dóza 100 ml

Ø 48,00 × 85,00 mm

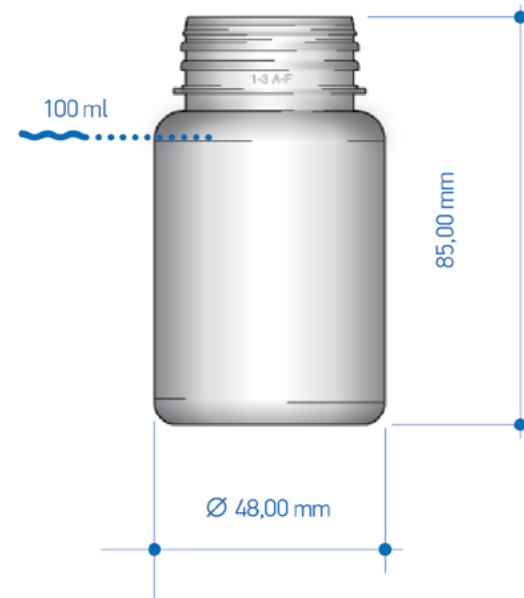

Dóza 150 ml

Ø 58,90 × 86,80 mm

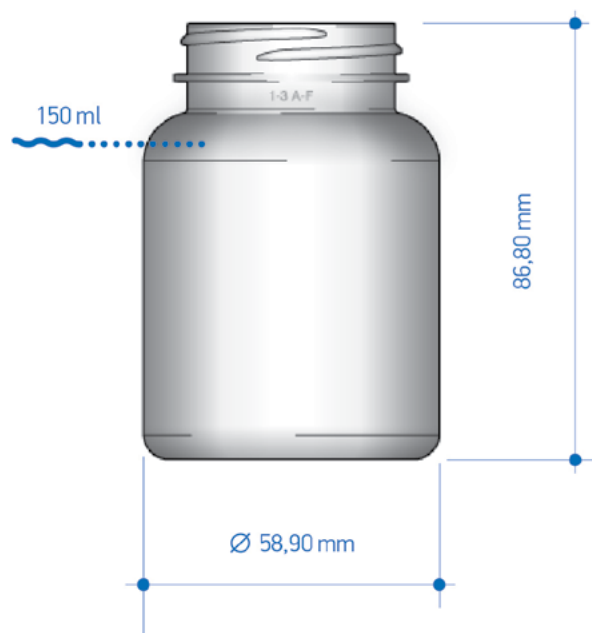

Dóza 200 ml

Ø 64,00 × 93,00 mm

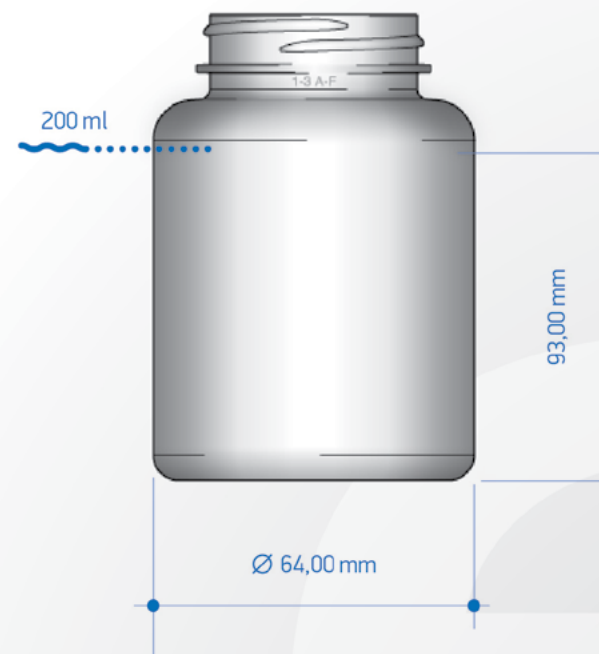

Dóza 200 ml

Ø 57,00 × 111,50 mm



Dóza 200 ml

Ø 56,00 × 121,00 mm

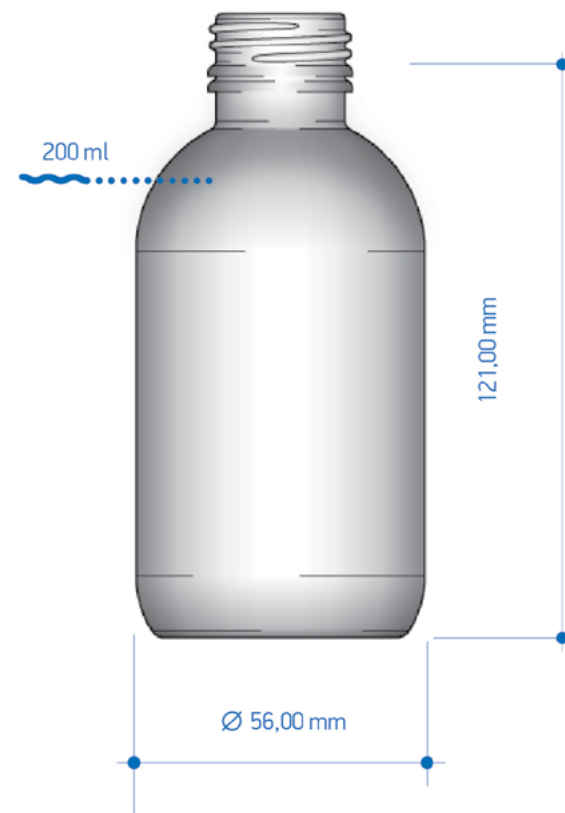

Dóza 120 ml

Ø 52,30×86,40 mm

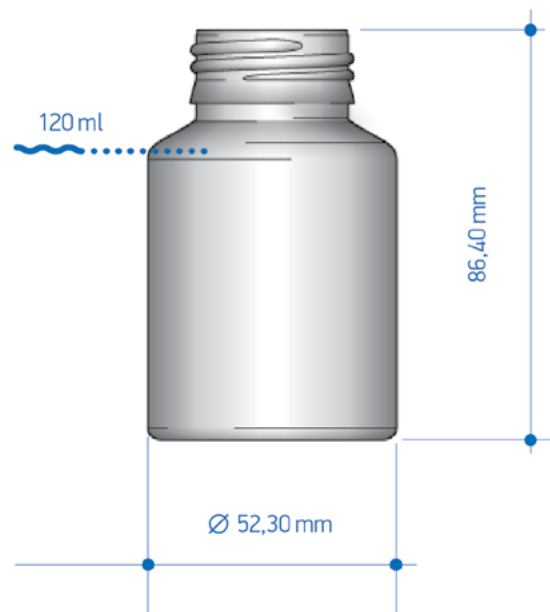

Dóza 150 ml

Ø 55,50×93,70 mm

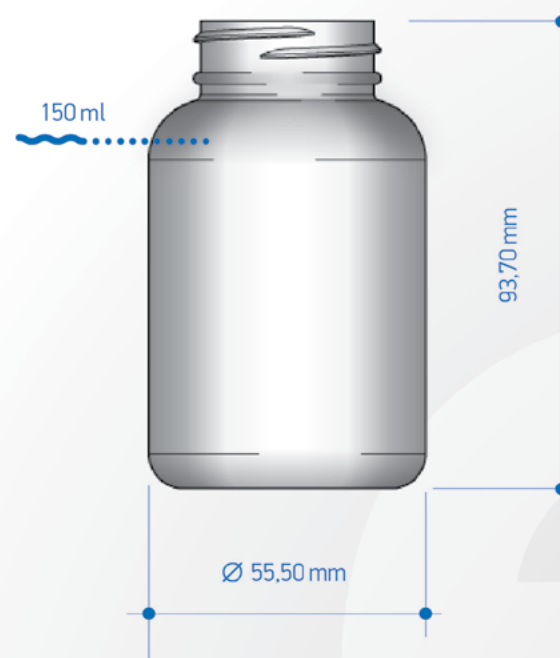

Dóza 250 ml

Ø 66,70 × 103,60 mm

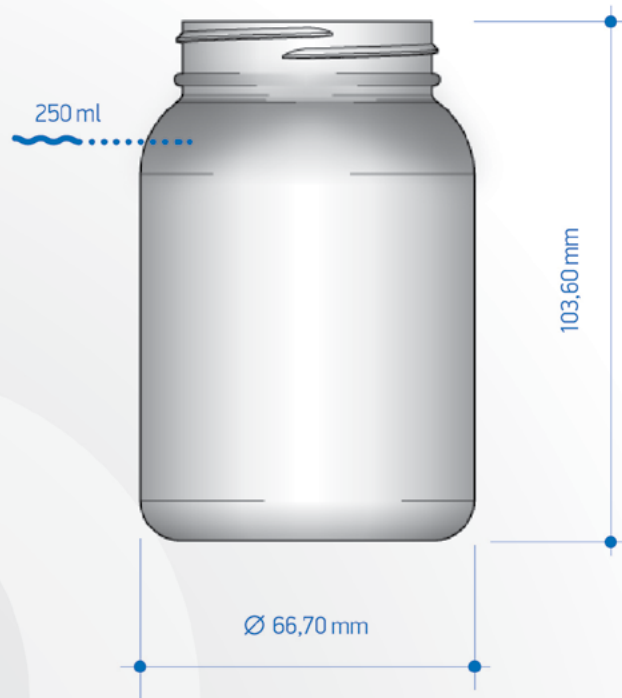

Dóza 300 ml

Ø 66,70 × 120,70 mm

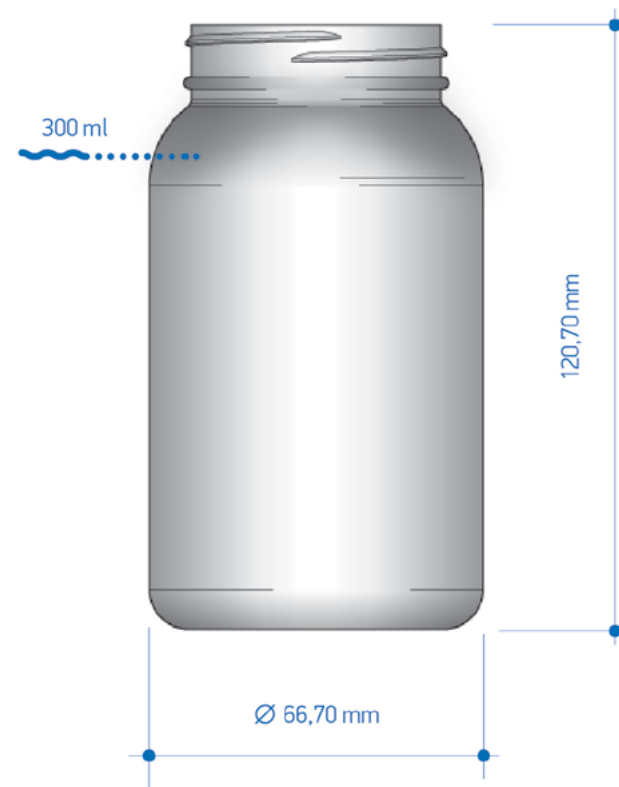

Dóza 500 ml

Ø 104,00×90,00mm

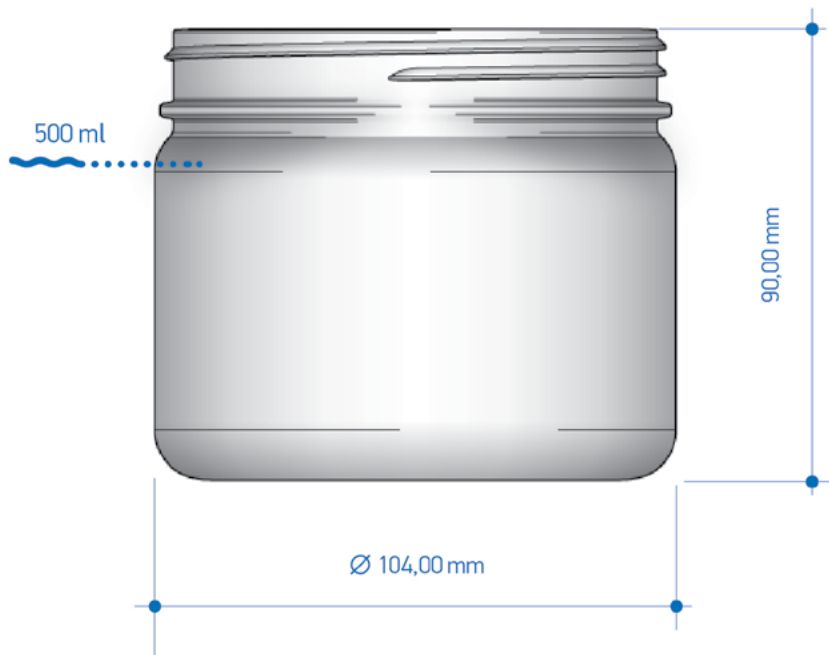

Dóza 750 ml

Ø 104,00×115,00mm

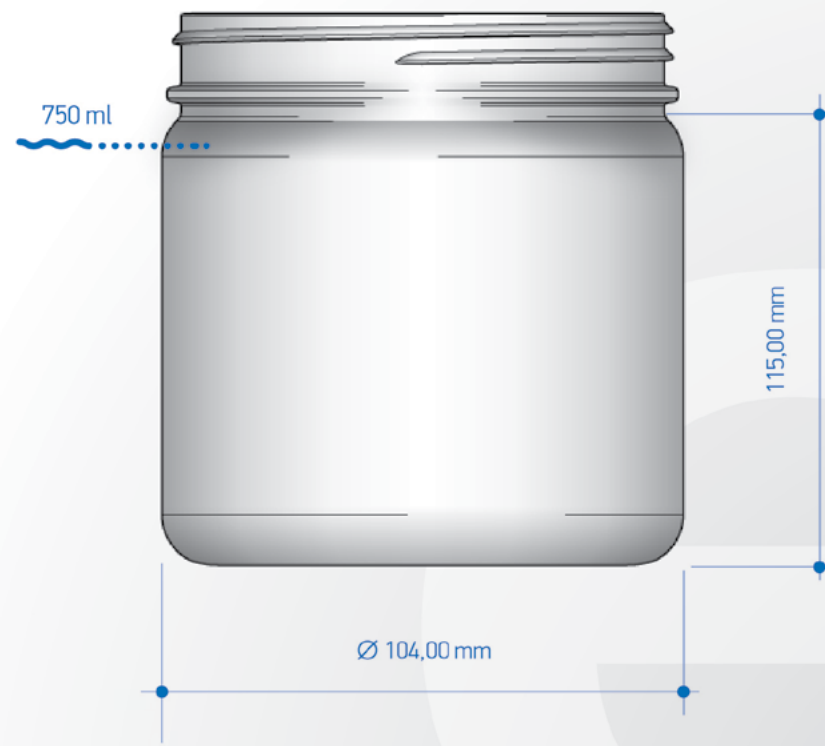

Dóza 500 ml

Ø 76,20 × 144,50 mm



Dóza 750 ml

Ø 85,70 × 171,80 mm

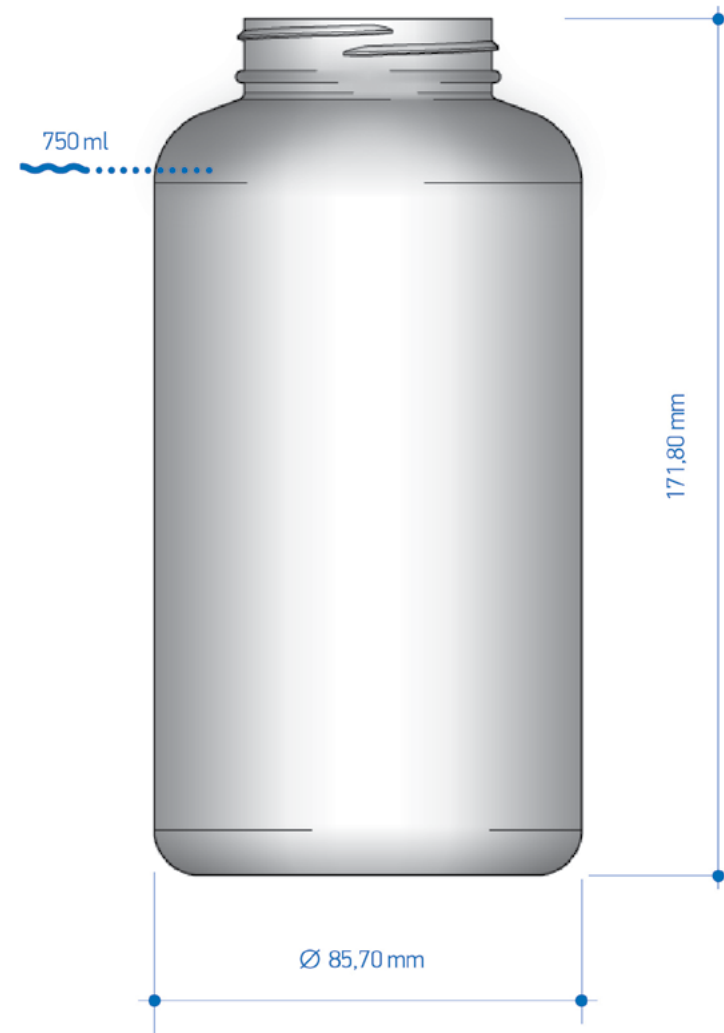

4. Lahve tekuté formy, shrink sleeve technologie

Nejčastější tvary a rozměry

PET shoty a lahve

Shot 60 ml

Ø 34,00×103,00 mm

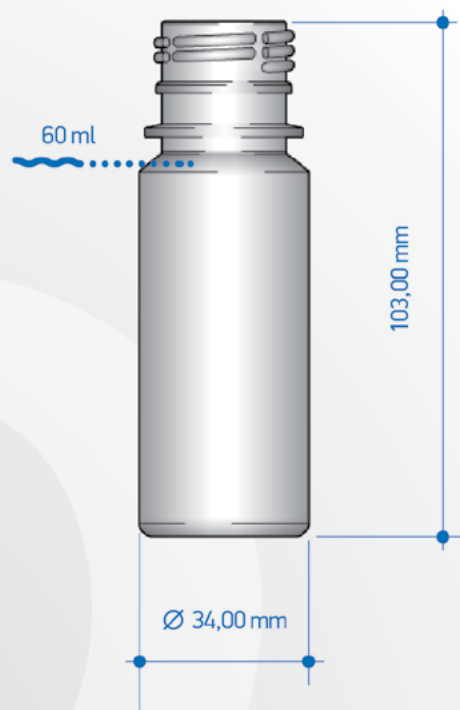

Lahev čirá, hnědá 300 ml

Ø 57,00×147,00 mm

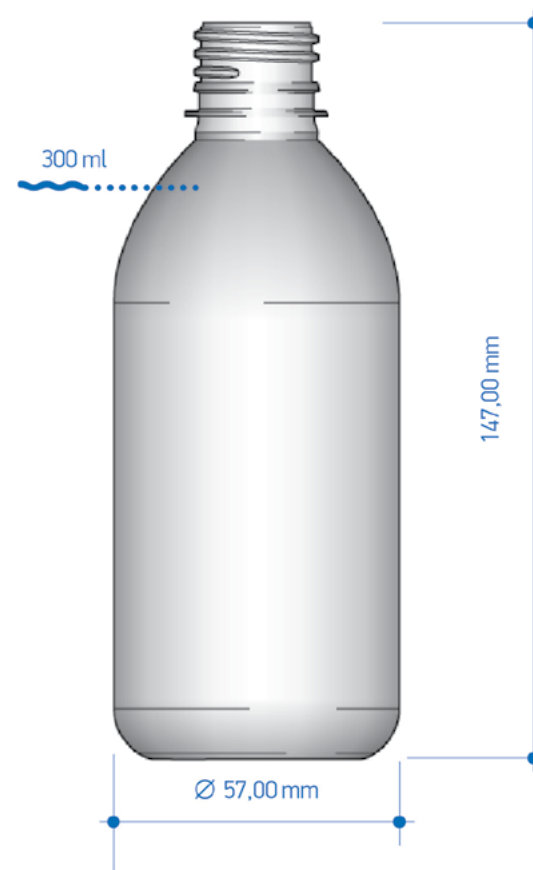

Lahev čirá, hnědá 500 ml

Ø 69,00 × 185,00 mm

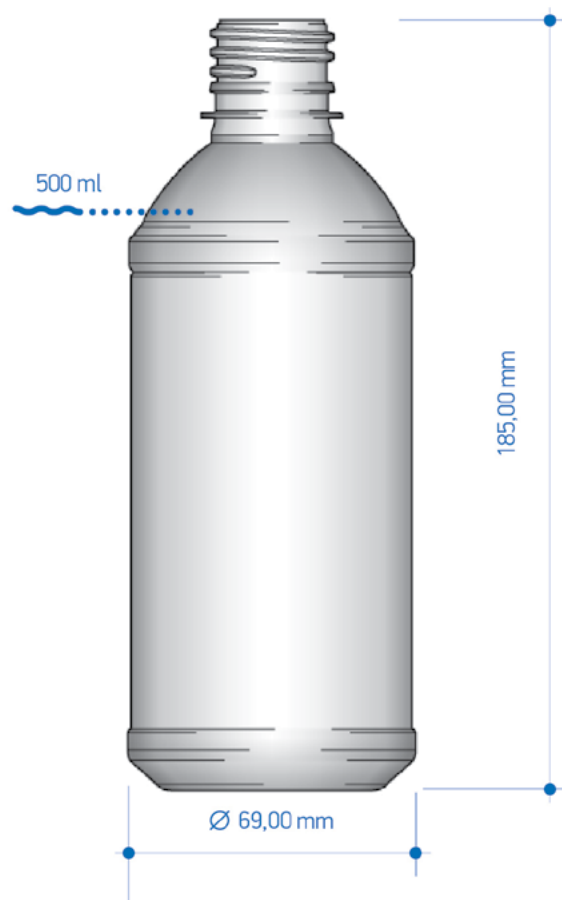

Lahev čirá, hnědá 1000 ml

Ø 81,00 × 245,00 mm

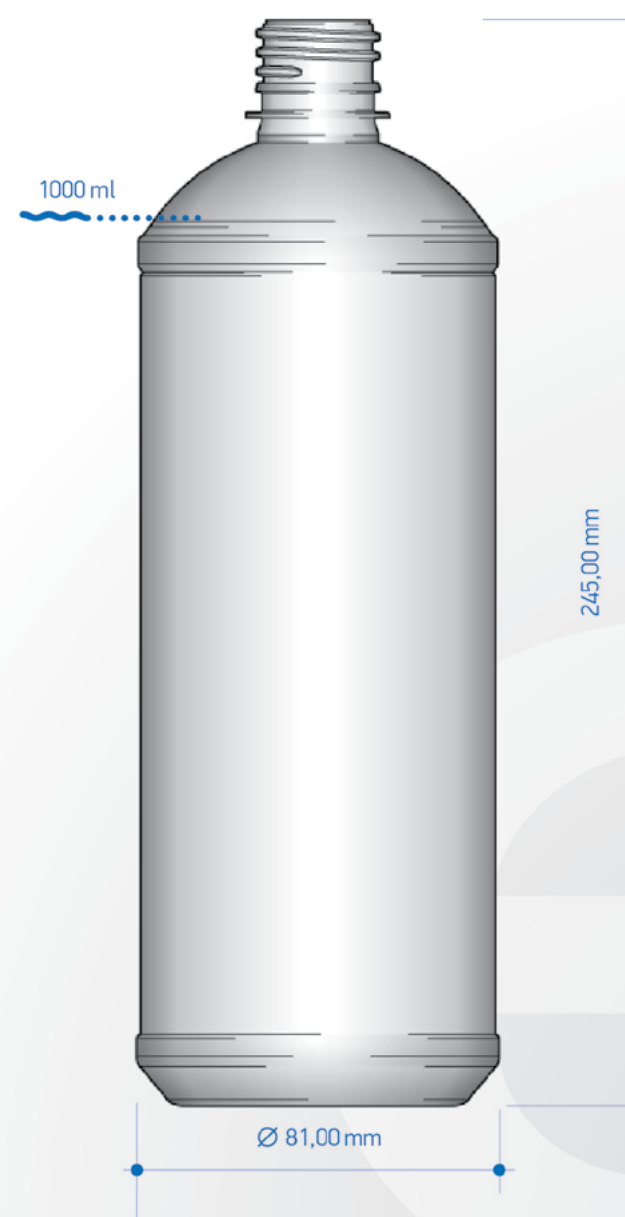

Shrink sleeve – smrštiteľné rukávové etikety

PET i HDPE shoty, dózy a lahve



KATALOG VÝROBNÍHO SORTIMENTU

NEOPHARMA a.s.
Kanice 104
664 01 Kanice
Česká republika

+420 602 359 538
obchod@neopharma.cz
www.neopharma.cz

